

SOT-363 Plastic-Encapsulate MOSFETS

UM6K1N Dual N-channel MOSFET

$V_{(BR)DSS}$	$R_{DS(on)MAX}$	I_D
30V	8Ω@4V	100mA
	13Ω@2.5V	

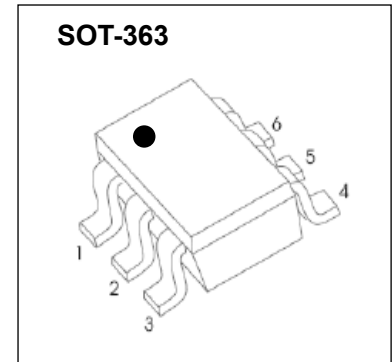

FEATURE

- 1) Two 2SK3018 transistors in a package.
- 2) The MOS FET elements are independent, eliminating mutual interference.
- 3) Mounting cost and area can be cut in half.
- 4) Low On-resistance.
- 5) Low voltage drive (2.5V drive) makes this device ideal for portable equipment.

MARKING

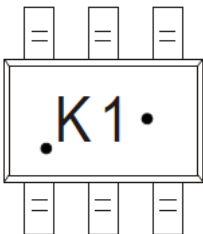

Equivalent Circuit

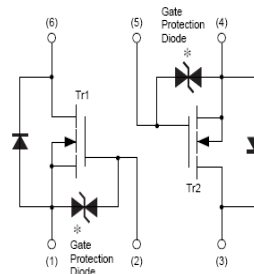

MOSFET MAXIMUM RATINGS (Ta = 25°C unless otherwise noted)

Symbol	Parameter	Value	Unit
V_{DS}	Drain-Source Voltage	30	V
V_{GS}	Gate-Source Voltage	±20	V
I_D	Continuous Drain Current	0.1	A
P_D	Power Dissipation	0.15	W
$R_{θJA}$	Thermal Resistance from Junction to Ambient	833	°C /W
T_J	Junction Temperature	150	°C
T_{stg}	Storage Temperature	-55~+150	°C

MOSFET ELECTRICAL CHARACTERISTICS

$T_a=25\text{ }^\circ\text{C}$ unless otherwise specified

Parameter	Symbol	Test Condition	Min	Typ	Max	Units
Off Characteristics						
Drain-Source Breakdown Voltage	V_{DS}	$V_{GS} = 0V, I_D = 10\mu A$	30			V
Zero Gate Voltage Drain Current	I_{BSS}	$V_{DS} = 30V, V_{GS} = 0V$			1	μA
Gate –Source leakage current	I_{GSS}	$V_{GS} = \pm 20V, V_{DS} = 0V$			± 2	μA
Gate Threshold Voltage	$V_{GS(th)}$	$V_{DS} = 3V, I_D = 100\mu A$	0.8	1.2	1.5	V
Drain-Source On-Resistance	$R_{DS(on)}$	$V_{GS} = 4V, I_D = 10mA$		4	8	Ω
		$V_{GS} = 2.5V, I_D = 1mA$		6	13	Ω
Forward Transconductance	g_{FS}	$V_{DS} = 3V, I_D = 10mA$	20			mS
Dynamic Characteristics*						
Input Capacitance	C_{iss}	$V_{DS} = 5V, V_{GS} = 0V, f = 1MHz$		13		pF
Output Capacitance	C_{oss}			9		pF
Reverse Transfer Capacitance	C_{rss}			4		pF
Switching Characteristics*						
Turn-On Delay Time	$t_{d(on)}$	$V_{GS} = 5V, V_{DD} = 5V,$ $I_D = 10mA, R_g = 10\Omega, R_L = 500\Omega$		15		ns
Rise Time	t_r			35		ns
Turn-Off Delay Time	$t_{d(off)}$			80		ns
Fall Time	t_f			80		ns

*These parameters have no way to verify.

Typical Characteristics

Output Characteristics

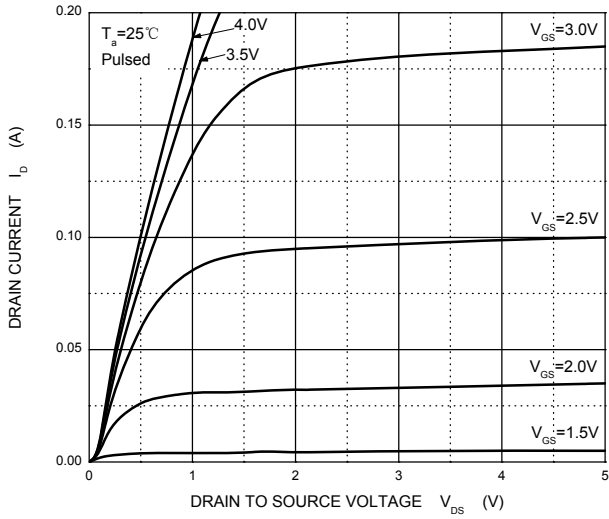

Transfer Characteristics

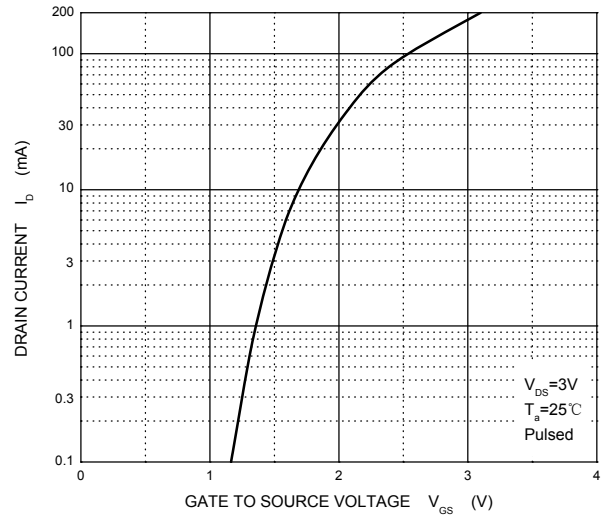

$R_{DS(ON)}$ — I_D

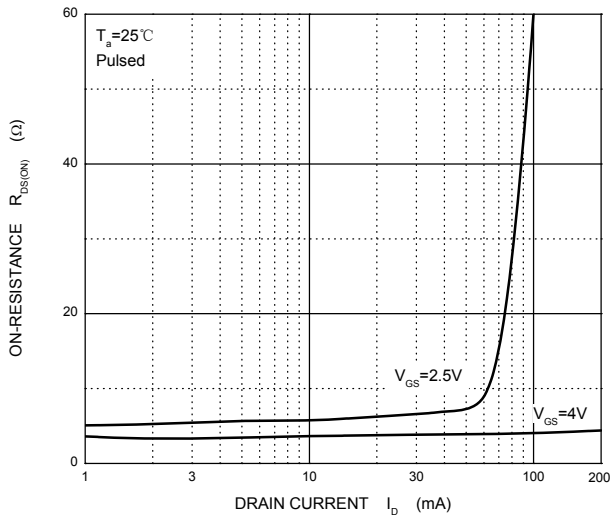

$R_{DS(ON)}$ — V_{GS}

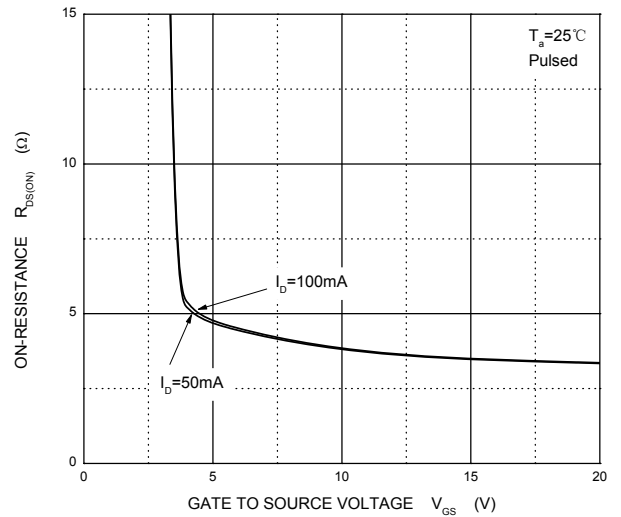

I_S — V_{SD}

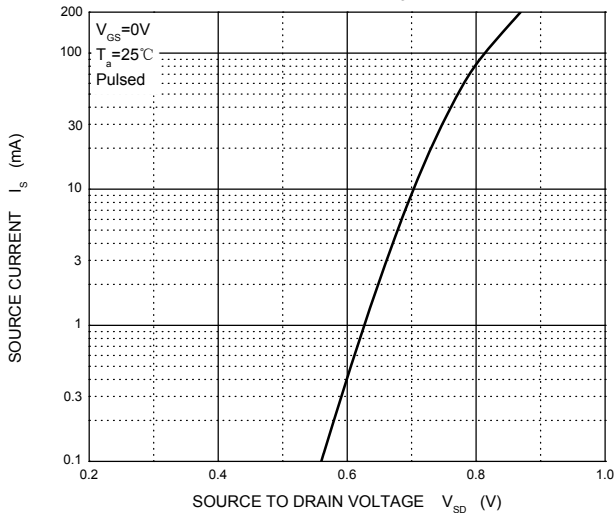

SOT-363 Package Outline Dimensions

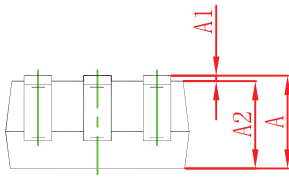
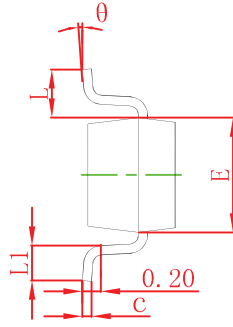
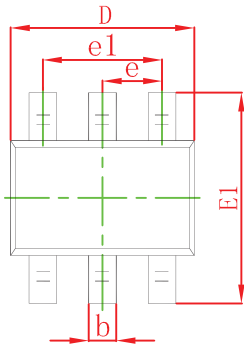

Symbol	Dimensions In Millimeters		Dimensions In Inches	
	Min	Max	Min	Max
A	0.900	1.100	0.035	0.043
A1	0.000	0.100	0.000	0.004
A2	0.900	1.000	0.035	0.039
b	0.150	0.350	0.006	0.014
c	0.100	0.150	0.004	0.006
D	2.000	2.200	0.079	0.087
E	1.150	1.350	0.045	0.053
E1	2.150	2.400	0.085	0.094
e	0.650 TYP		0.026 TYP	
e1	1.200	1.400	0.047	0.055
L	0.525 REF		0.021 REF	
L1	0.260	0.460	0.010	0.018
theta	0°	8°	0°	8°

SOT-363 Suggested Pad Layout

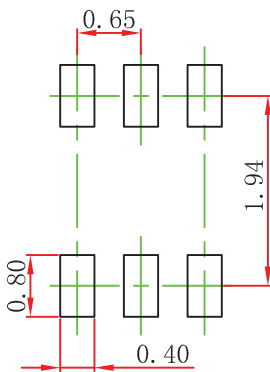

Note:

1. Controlling dimension: in millimeters.
2. General tolerance: $\pm 0.05\text{mm}$.
3. The pad layout is for reference purposes only.

NOTICE

JCET reserve the right to make modifications, enhancements, improvements, corrections or other changes without further notice to any product herein. JCET does not assume any liability arising out of the application or use of any product described herein.

SOT-363 Tape and reel

SOT-363 Embossed Carrier Tape

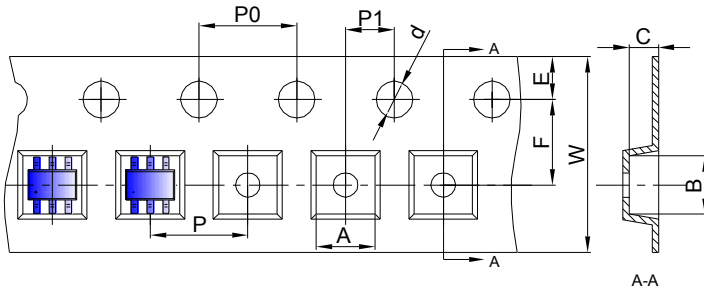

Packaging Description:

SOT-363 parts are shipped in tape. The carrier tape is made from a dissipative (carbon filled) polycarbonate resin. The cover tape is a multilayer film (Heat Activated Adhesive in nature) primarily composed of polyester film, adhesive layer, sealant, and anti-static sprayed agent. These reeled parts in standard option are shipped with 3,000 units per 7" or 17.8cm diameter reel. The reels are clear in color and is made of polystyrene plastic (anti-static coated).

Dimensions are in millimeter										
Pkg type	A	B	C	d	E	F	P0	P	P1	W
SOT-363	2.25	2.55	1.20	Ø1.50	1.75	3.50	4.00	4.00	2.00	8.00

SOT-363 Tape Leader and Trailer

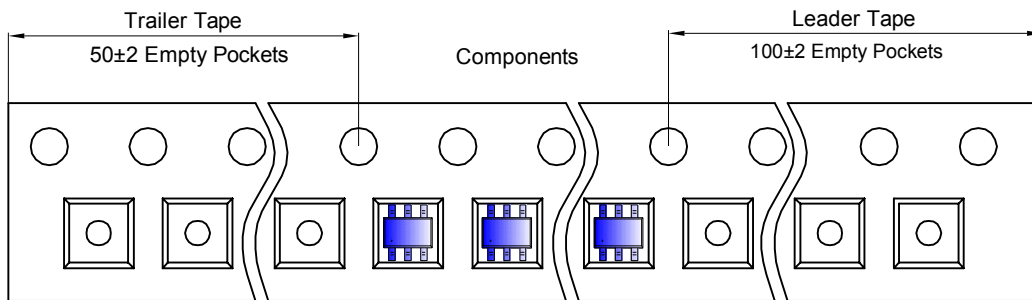

SOT-363 Reel

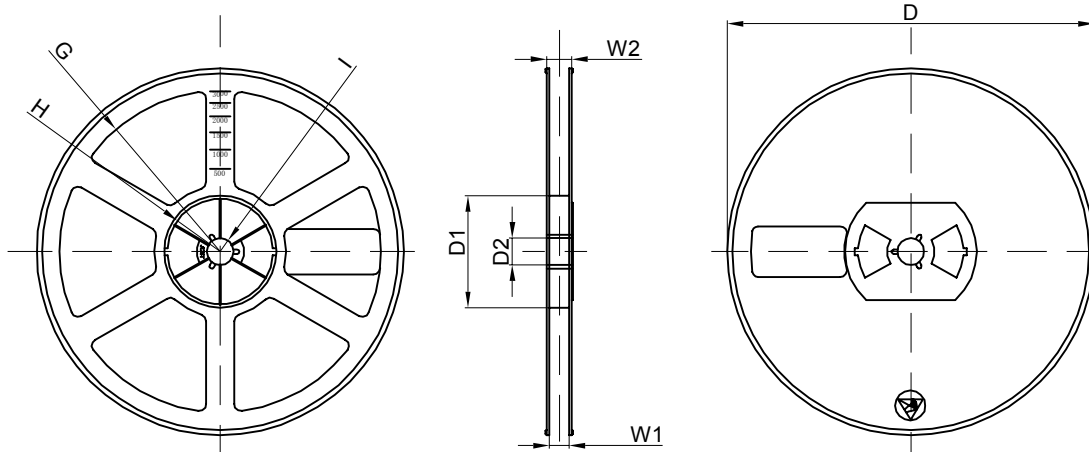

Dimensions are in millimeter								
Reel Option	D	D1	D2	G	H	I	W1	W2
7" Dia	Ø178.00	54.40	13.00	R78.00	R25.60	R6.50	9.50	12.30

REEL	Reel Size	Box	Box Size(mm)	Carton	Carton Size(mm)	G.W.(kg)
3000 pcs	7 inch	30,000 pcs	203×203×195	120,000 pcs	438×438×220	