

NCE15GD120T

NCE15GD120T

1200V, 15A, Trench NPT IGBT

Features

- Trench NPT(Non Punch Through) IGBT
- High speed switching
- Low saturation voltage: $V_{CE(sat)}=2.0V@I_C=15A$
- High input impedance



Applications

- Inductive heating, Microwave oven, Inverter, UPS, etc.
- Soft switching applications

General Description

Using advanced Trench NPT technology, NCE's 1200V IGBTs offers superior conduction and switching performances, and easy parallel operation with exceptional avalanche ruggedness. This device is designed for soft switching applications.

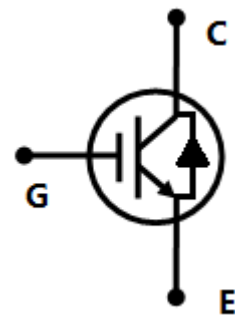

Absolute Maximum Ratings

Symbol	Description	Ratings	Units
V_{CES}	Collector to Emitter Voltage	1200	V
V_{GES}	Gate to Emitter Voltage	+/-30	V
I_C	Continuous Collector Current @ $T_C=25^{\circ}C$	30	A
	Continuous Collector Current @ $T_C=100^{\circ}C$	15	A
$I_{CM}(1)$	Pulsed Collector Current	45	A
I_F	Diode Continuous Forward Current @ $T_C=100^{\circ}C$	15	
I_{FM}	Diode Maximum Forward Current	90	A
P_D	Maximum Power Dissipation @ $T_C=25^{\circ}C$	220	W
	Maximum Power Dissipation @ $T_C=100^{\circ}C$	88	W
T_J	Operating Junction Temperature	-55 to +150	$^{\circ}C$
T_{stg}	Storage Temperature Range	-55 to +150	$^{\circ}C$
T_L	Maximum Lead Temp. for soldering Purposes, 1/8" from case for 5seconds	300	$^{\circ}C$

Notes:

1. Repetitive rating, Pulse width limited by max. junction temperature

Thermal Characteristics

Symbol	Parameter	Typ.	Max.	Units
$R_{\square JC}$	Thermal Resistance, Junction to Case	-	0.57	$^{\circ}C/W$
R_{JA}	Thermal Resistance, Junction to Ambient	-	40	$^{\circ}C/W$

Electrical Characteristics of the IGBT $T_C=25^{\circ}C$

Symbol	Parameter	Test Conditions	Min.	Typ.	Max.	Units
Off Characteristics						
BV_{CES}	Collector to Emitter Breakdown Voltage	$V_{GE}=0V, I_C=1mA$	1200	-	-	V
I_{CES}	Collector Cut-Off Current	$V_{CE}=V_{CES}, V_{GE}=0V$	-	-	1	mA
I_{GES}	G-E Leakage Current	$V_{GE}=V_{GES}, V_{CE}=0V$	-	-	+/-250	nA
On Characteristics						
$V_{GE(th)}$	G-E Threshold Voltage	$I_C=15mA, V_{CE}=V_{GE}$	4.0	5.5	7.0	V
$V_{CE(sat)}$	Collector to Emitter Saturation Voltage	$I_C=15A, V_{GE}=15V$ $T_C=25^{\circ}C$	-	2	2.5	V
		$I_C=15A, V_{GE}=15V$ $T_C=125^{\circ}C$	-	2.15	-	V
Dynamic Characteristics						
C_{ies}	Input Capacitance	$V_{CE}=30V, V_{GE}=0V,$ $f=1MHz$	-	2350	-	pF
C_{oes}	Output Capacitance		-	70	-	pF
C_{res}	Reverse Transfer Capacitance		-	45	-	pF
Switching Characteristics						
$t_{d(on)}$	Turn-On Delay Time	$V_{CC}=600V, I_C=15A,$ $R_G=10\Omega, V_{GE}=15V,$ Resistive Load, $T_C=25^{\circ}C$	-	33	-	ns
t_r	Rise Time		-	80	-	ns
$t_{d(off)}$	Turn-Off Delay Time		-	160	-	ns
t_f	Fall Time		-	255	330	ns
E_{on}	Turn-On Switching Loss		-	0.3	-	mJ
E_{off}	Turn-Off Switching Loss		-	0.58	0.74	mJ
E_{ts}	Total Switching Loss		-	0.88	-	mJ
$t_{d(on)}$	Turn-On Delay Time	$V_{CC}=600V, I_C=15A,$ $R_G=10\Omega, V_{GE}=15V,$ Resistive Load, $T_C=125^{\circ}C$	-	30	-	ns
t_r	Rise Time		-	115	-	ns
$t_{d(off)}$	Turn-Off Delay Time		-	170	-	ns
t_f	Fall Time		-	390	-	ns
E_{on}	Turn-On Switching Loss		-	0.38	-	mJ
E_{off}	Turn-Off Switching Loss		-	0.89	-	mJ
E_{ts}	Total Switching Loss		-	1.27	-	mJ
Q_g	Total Gate Charge	$V_{CC}=600V, I_C=15A,$ $V_{GE}=15V$	-	100	-	nC
Q_{ge}	Gate to Emitter Charge		-	19	-	nC
Q_{gc}	Gate to Collector Charge		-	45	-	nC



NCE15GD120T

Electrical Characteristics of Diode $T_C=25^\circ\text{C}$

Symbol	Parameter	Test Conditions	Min.	Typ.	Max.	Units
V_{FM}	Diode Forward Voltage	$I_F=15\text{A}$	25°C	1.4	1.8	V
			125°C	1.42		V
t_{rr}	Diode Reverse Recovery Time	$I_F=15\text{A},$ $di/dt=200\text{A}/\mu\text{s}$	25°C	575		ns
			125°C	577		ns
I_{rr}	Diode Peak Reverse Recovery Current		25°C	30		A
			125°C	37		A
Q_{rr}	Diode Reverse Recovery Charge		25°C	8.7		μC
			125°C	10.7		μC

Typical Performance Characteristics

Figure 1. Typical Output Characteristics

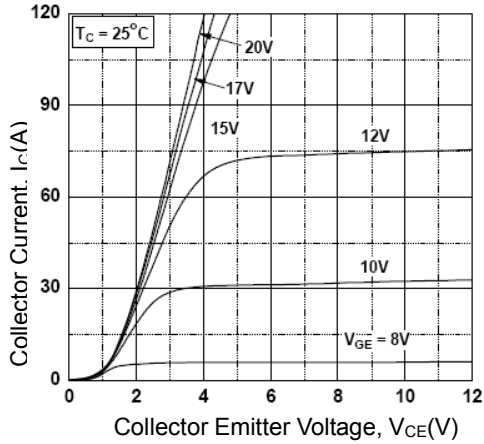

Figure 2. Typical Saturation Voltage Characteristics

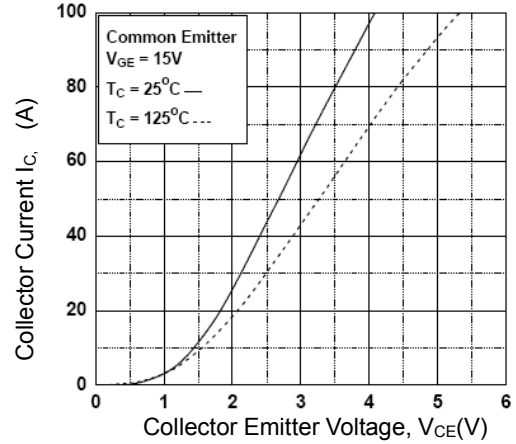

Figure 3. Saturation Voltage vs. Case Temperature at Variant Current Level

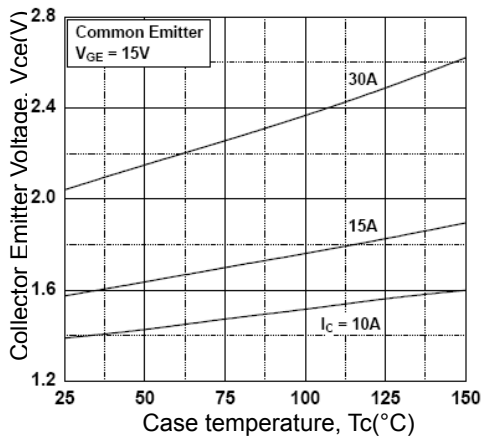

Figure 4. Saturation Voltage vs. V_GE

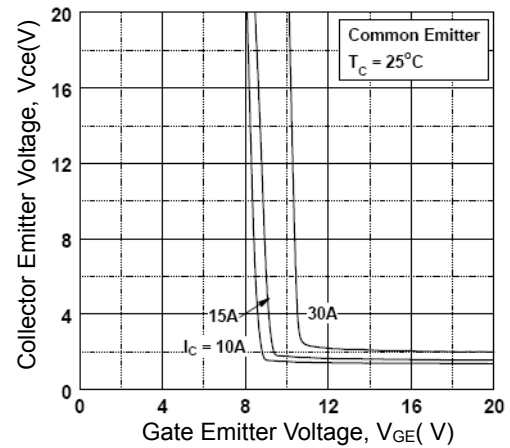

Figure 5. Saturation Voltage vs. V_GE

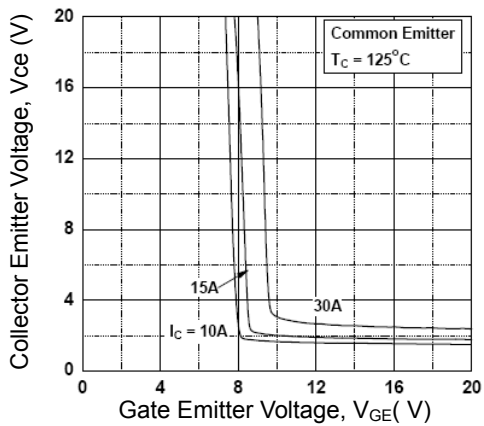
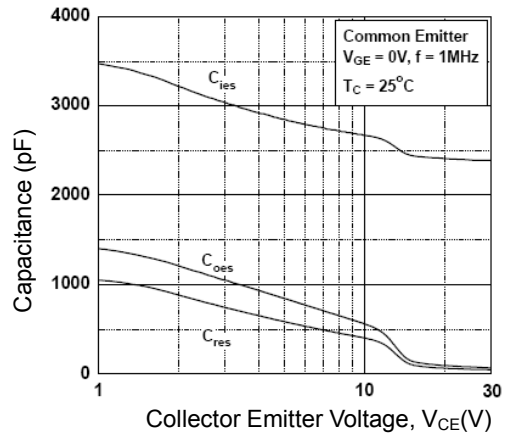

Figure 6. Capacitance Characteristics



Typical Performance Characteristics (Continued)

Figure 7. Turn-on Characteristics vs. Gate Resistance

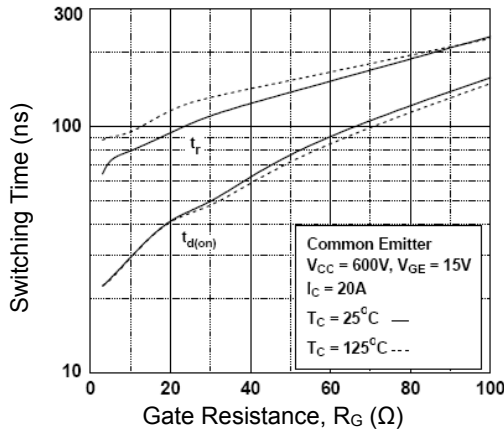

Figure 8. Turn-off Characteristics vs. Gate Resistance

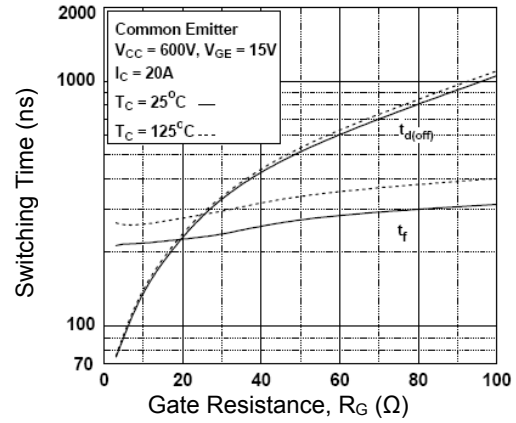

Figure 9. Switching Loss vs. Gate Resistance

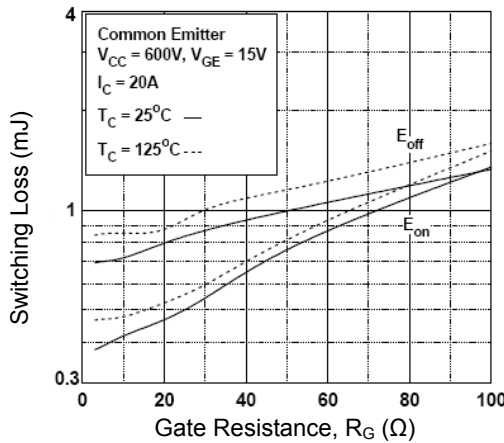

Figure 10. Turn-on Characteristics vs. Collector Current

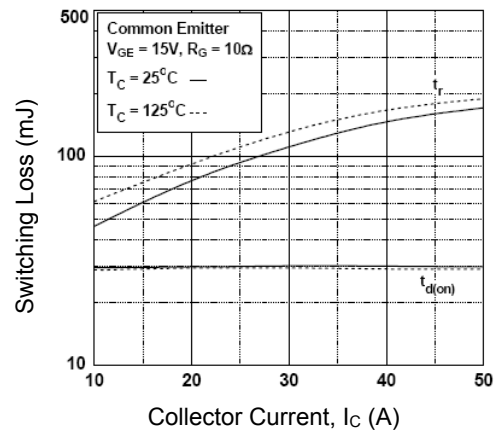

Figure 11. Turn-Off Characteristics vs. Collector Current

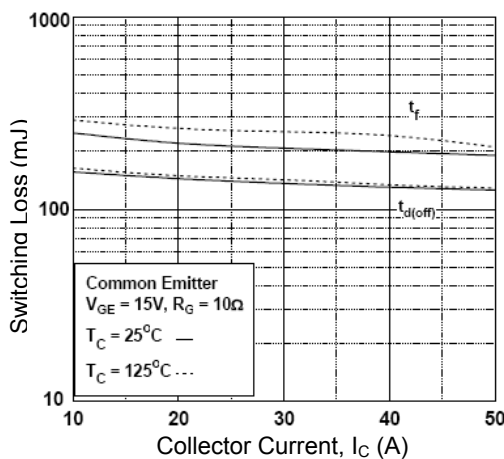
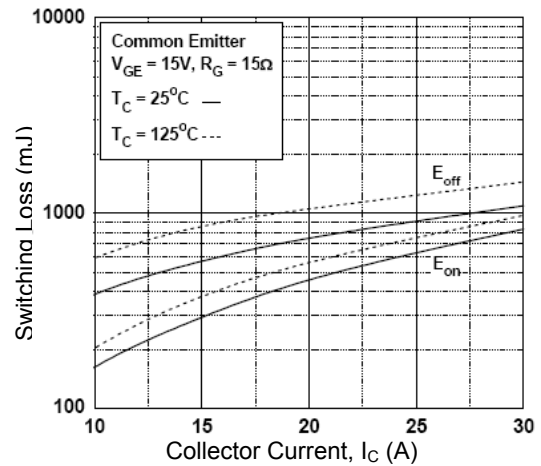

Figure 12. Switching Loss vs. Collector Current



Typical Performance Characteristics (Continued)

Figure 13. Gate Charge Characteristics

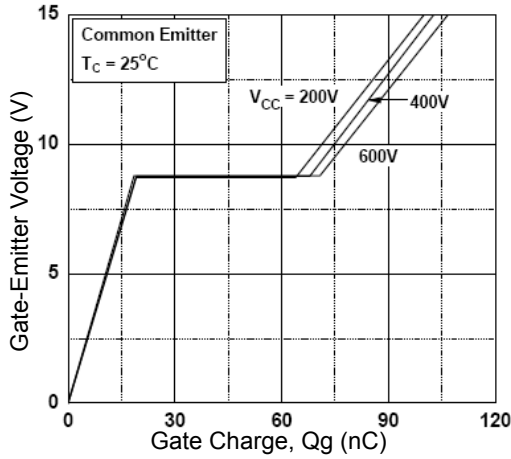

Figure 14. SOA Characteristics

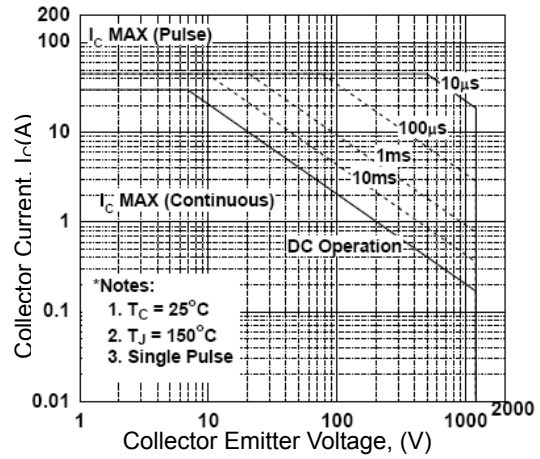

Figure 15. Turn-Off SOA

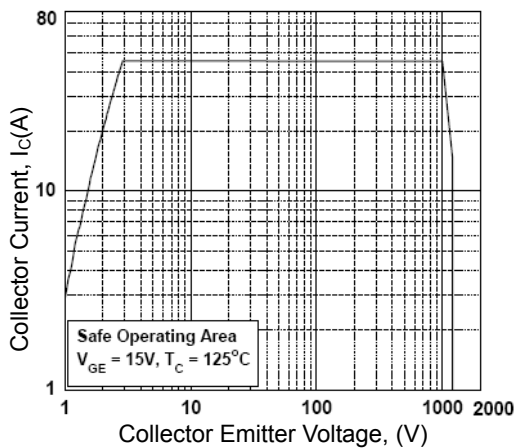
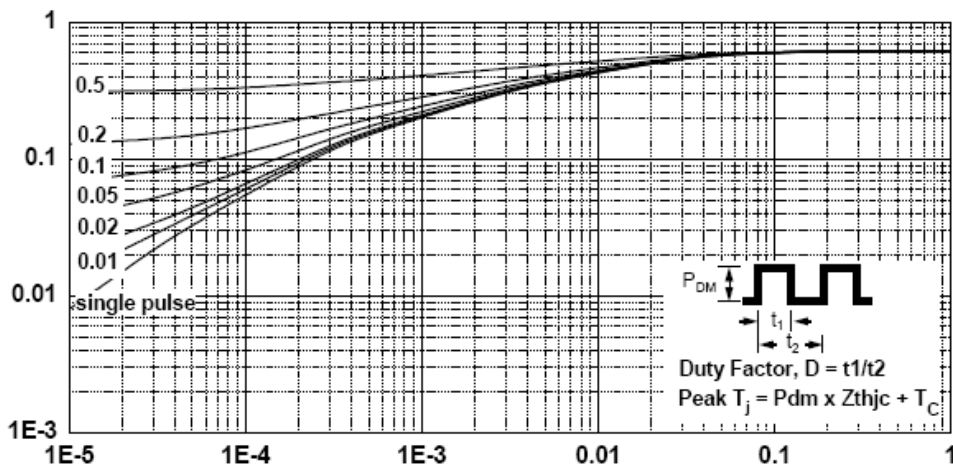
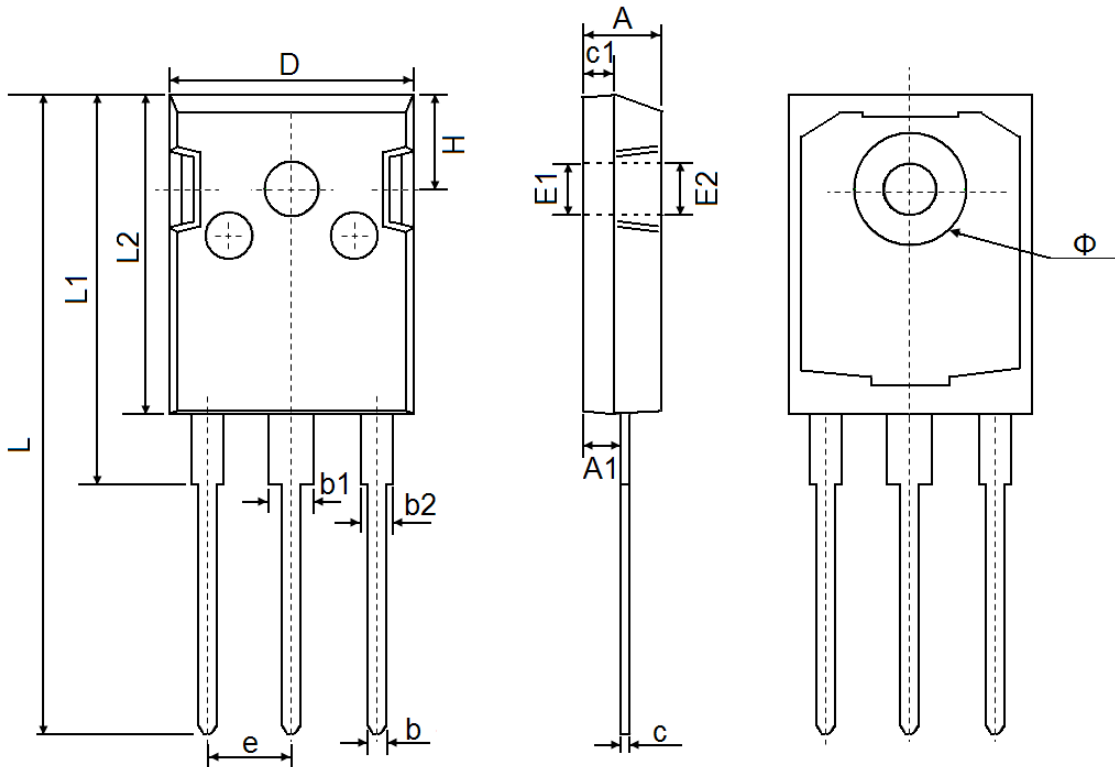

Figure 16. Transient Thermal Impedance of IGBT



TO-247 Package Information



Symbol	Dimensions In Millimeters		Dimensions In Inches	
	Min.	Max.	Min.	Max.
A	4.850	5.150	0.191	0.200
A1	2.200	2.600	0.087	0.102
b	1.000	1.400	0.039	0.055
b1	2.800	3.200	0.110	0.126
b2	1.800	2.200	0.071	0.087
c	0.500	0.700	0.020	0.028
c1	1.900	2.100	0.075	0.083
D	15.450	15.750	0.608	0.620
E1	3.500 REF		0.138 REF	
E2	3.600 REF		0.142 REF	
L	40.900	41.300	1.610	1.626
L1	24.800	25.100	0.976	0.988
L2	20.300	20.600	0.799	0.811
Φ	7.100	7.300	0.280	0.287
e	5.450 TYP		0.215 TYP	
H	5.980 REF		0.235 REF	



ATTENTION:

- Any and all NCE products described or contained herein do not have specifications that can handle applications that require extremely high levels of reliability, such as life-support systems, aircraft's control systems, or other applications whose failure can be reasonably expected to result in serious physical and/or material damage. Consult with your NCE representative nearest you before using any NCE products described or contained herein in such applications.
- NCE assumes no responsibility for equipment failures that result from using products at values that exceed, even momentarily, rated values (such as maximum ratings, operating condition ranges, or other parameters) listed in products specifications of any and all NCE products described or contained herein.
- Specifications of any and all NCE products described or contained herein stipulate the performance, characteristics, and functions of the described products in the independent state, and are not guarantees of the performance, characteristics, and functions of the described products as mounted in the customer's products or equipment. To verify symptoms and states that cannot be evaluated in an independent device, the customer should always evaluate and test devices mounted in the customer's products or equipment.
- NCE Power Semiconductor CO.,LTD. strives to supply high-quality high-reliability products. However, any and all semiconductor products fail with some probability. It is possible that these probabilistic failures could give rise to accidents or events that could endanger human lives, that could give rise to smoke or fire, or that could cause damage to other property. When designing equipment, adopt safety measures so that these kinds of accidents or events cannot occur. Such measures include but are not limited to protective circuits and error prevention circuits for safe design, redundant design, and structural design.
- In the event that any or all NCE products(including technical data, services) described or contained herein are controlled under any of applicable local export control laws and regulations, such products must not be exported without obtaining the export license from the authorities concerned in accordance with the above law.
- No part of this publication may be reproduced or transmitted in any form or by any means, electronic or mechanical, including photocopying and recording, or any information storage or retrieval system, or otherwise, without the prior written permission of NCE Power Semiconductor CO.,LTD.
- Information (including circuit diagrams and circuit parameters) herein is for example only ; it is not guaranteed for volume production. NCE believes information herein is accurate and reliable, but no guarantees are made or implied regarding its use or any infringements of intellectual property rights or other rights of third parties.
- Any and all information described or contained herein are subject to change without notice due to product/technology improvement, etc. When designing equipment, refer to the "Delivery Specification" for the NCE product that you intend to use.
- This catalog provides information as of Mar. 2010. Specifications and information herein are subject to change without notice.