

MMBTRC241SS...MMBTRC246SS

NPN Silicon Epitaxial Planar Transistor

for high current switching, interface circuit and driver circuit application.

Feature

- With built-in bias resistors
- Simplify circuit design
- Reduce a quantity of parts and manufacturing Process

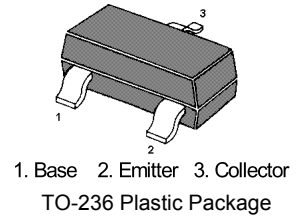
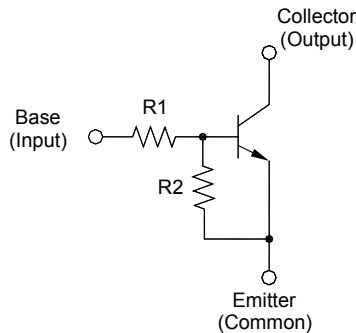

Resistor Values

Type	R1 (K Ω)	R2 (K Ω)
MMBTRC241SS	1	1
MMBTRC242SS	2.2	2.2
MMBTRC243SS	4.7	4.7
MMBTRC244SS	10	10
MMBTRC245SS	1	10
MMBTRC246SS	2.2	10

Absolute Maximum Ratings ($T_a = 25^\circ\text{C}$)

Parameter		Symbol	Value	Unit
Output Voltage		V_o	50	V
Input Voltage	MMBTRC241SS	V_i	10, -10	V
	MMBTRC242SS		12, -10	
	MMBTRC243SS		20, -10	
	MMBTRC244SS		30, -10	
	MMBTRC245SS		10, -5	
	MMBTRC246SS		12, -6	
Output Current		I_o	300	mA
Total Power Dissipation		P_{tot}	200	mW
Junction Temperature		T_j	150	$^\circ\text{C}$
Storage Temperature Range		T_{stg}	- 55 to + 150	$^\circ\text{C}$

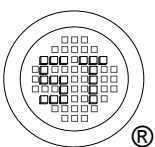

SEMTECH ELECTRONICS LTD.



Dated : 16/03/2015 Rev:01

MMBTRC241SS...MMBTRC246SS

Characteristics at $T_a = 25\text{ }^\circ\text{C}$

Parameter	Symbol	Min.	Typ.	Max.	Unit
DC Current Gain at $V_O = 5\text{ V}$, $I_O = 50\text{ mA}$	MMBTRC241SS	33	-	-	-
	MMBTRC242SS	39	-	-	-
	MMBTRC243SS	47	-	-	-
	MMBTRC244SS	56	-	-	-
	MMBTRC245SS	56	-	-	-
	MMBTRC246SS	56	-	-	-
Output Cutoff Current at $V_O = 30\text{ V}$	$I_{O(OFF)}$	-	-	10	μA
Input Current at $V_I = 5\text{ V}$	MMBTRC241SS	-	-	7.2	mA
	MMBTRC242SS	-	-	3.8	
	MMBTRC243SS	-	-	1.8	
	MMBTRC244SS	-	-	0.88	
	MMBTRC245SS	-	-	7.2	
	MMBTRC246SS	-	-	3.6	
Output Voltage at $I_O = 10\text{ mA}$, $I_I = 0.5\text{ mA}$	$V_{O(ON)}$	-	-	0.3	V
Input Voltage (ON) at $V_O = 0.3\text{ V}$, $I_O = 20\text{ mA}$	MMBTRC241SS	-	-	3	V
	MMBTRC242SS	-	-	3	
	MMBTRC243SS	-	-	3	
	MMBTRC244SS	-	-	3	
	MMBTRC245SS	-	-	3	
	MMBTRC246SS	-	-	2	
Input Voltage (OFF) at $V_O = 5\text{ V}$, $I_O = 0.1\text{ mA}$	MMBTRC241SS~244SS	$-V_{I(OFF)}$	0.5	-	V
	MMBTRC245SS~246SS		0.3	-	
Transition Frequency at $V_O = 10\text{ V}$, $I_O = 5\text{ mA}$, $f = 100\text{ MHz}$	f_T ¹⁾	-	200	-	MHz

¹⁾ Characteristic of transistor only.

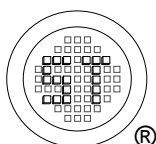

SEMTECH ELECTRONICS LTD.



Dated : 16/03/2015 Rev:01

MMBTRC241SS...MMBTRC246SS

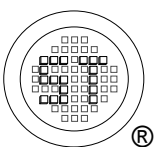
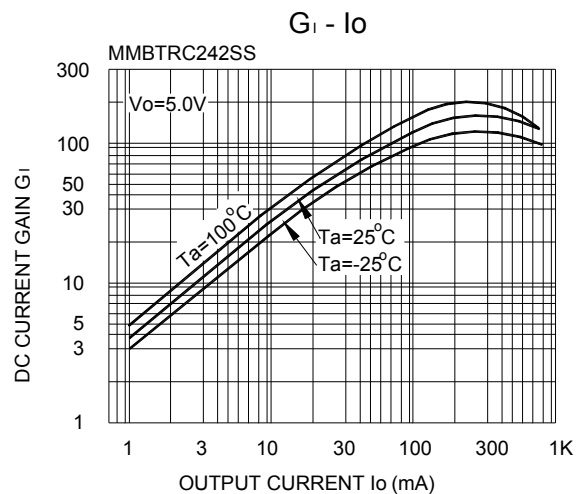
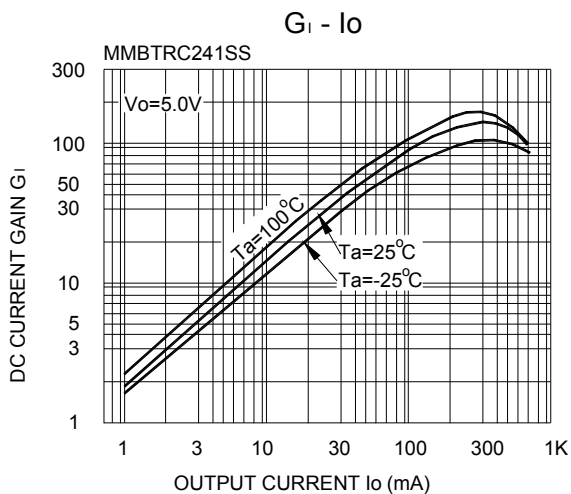
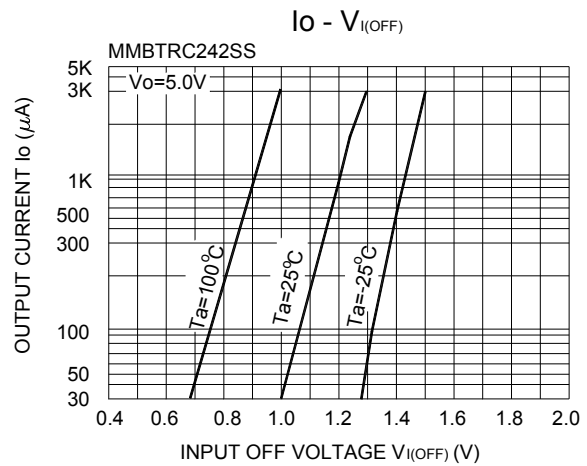
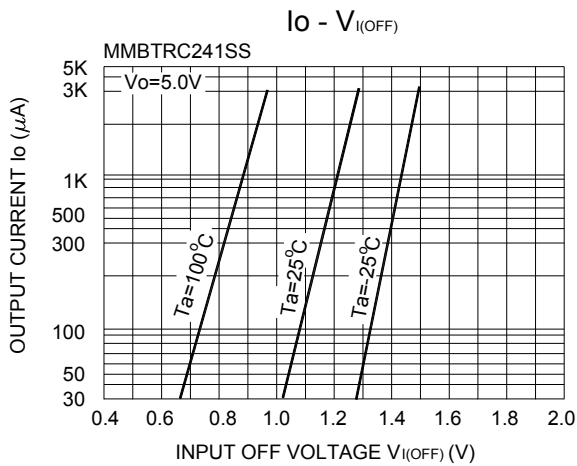
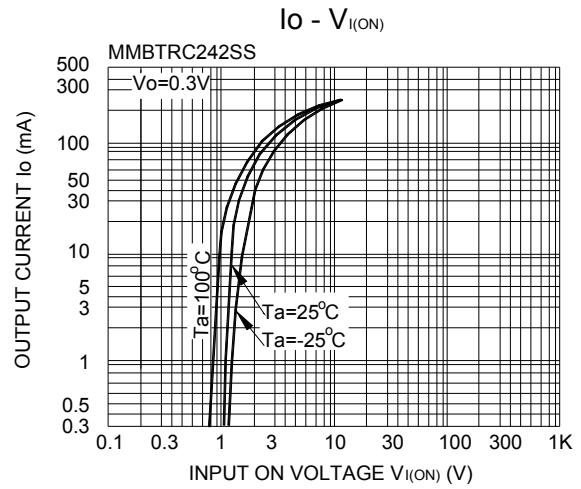
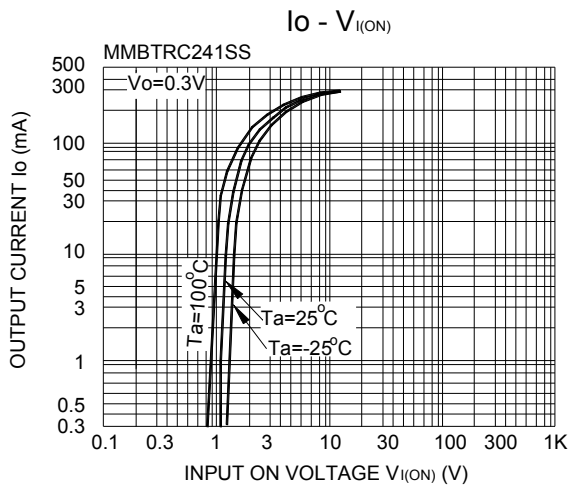

SEMTECH ELECTRONICS LTD.



MMBTRC241SS...MMBTRC246SS

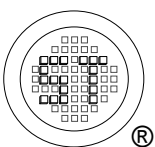
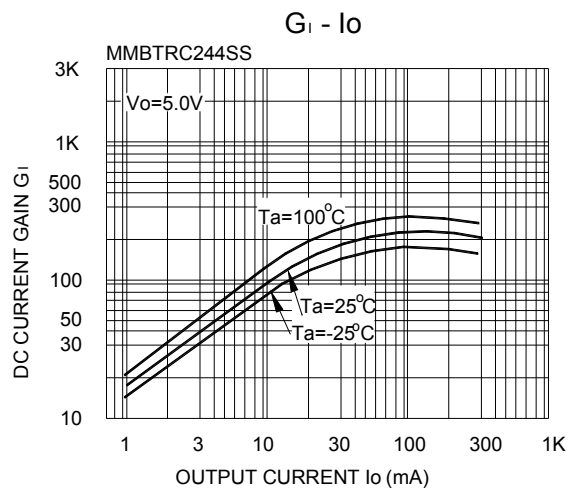
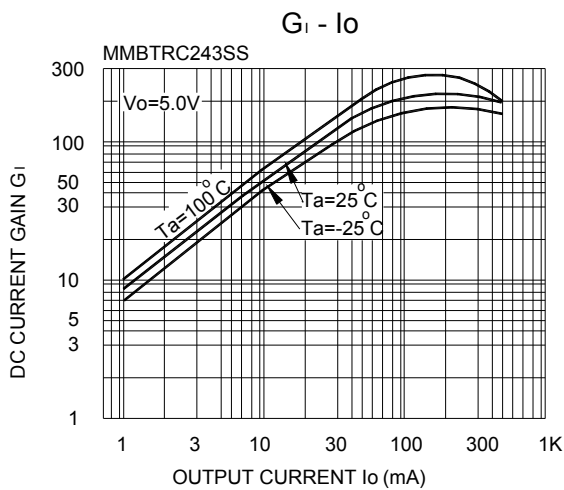
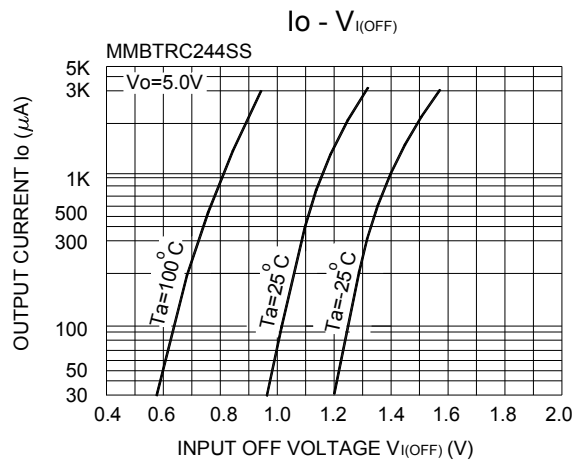
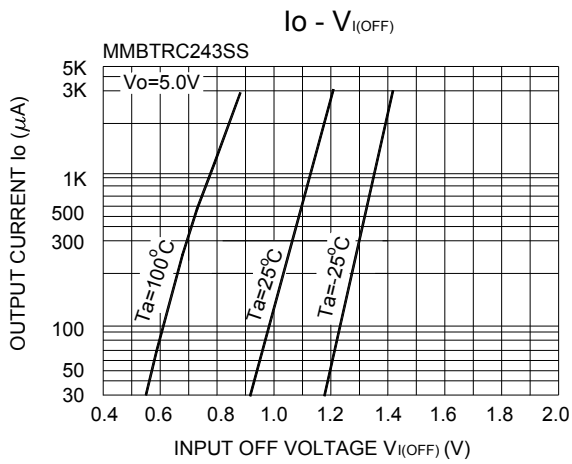
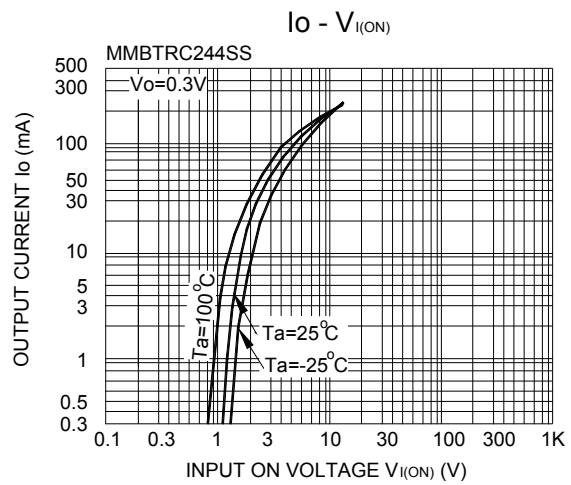
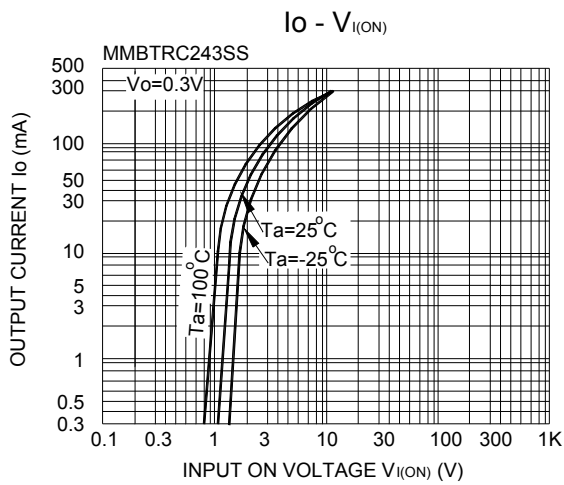

SEMTECH ELECTRONICS LTD.



MMBTRC241SS...MMBTRC246SS

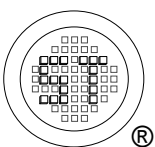
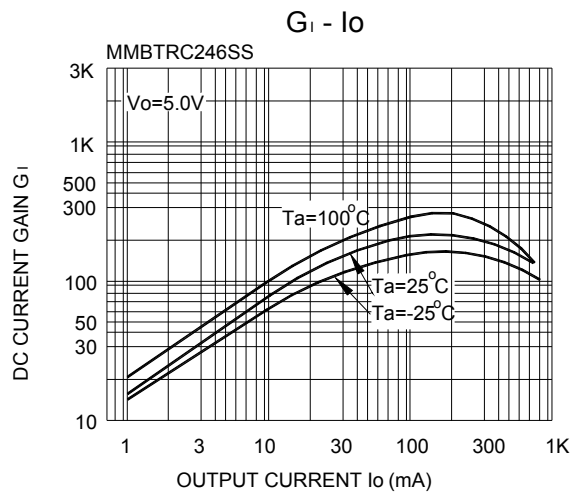
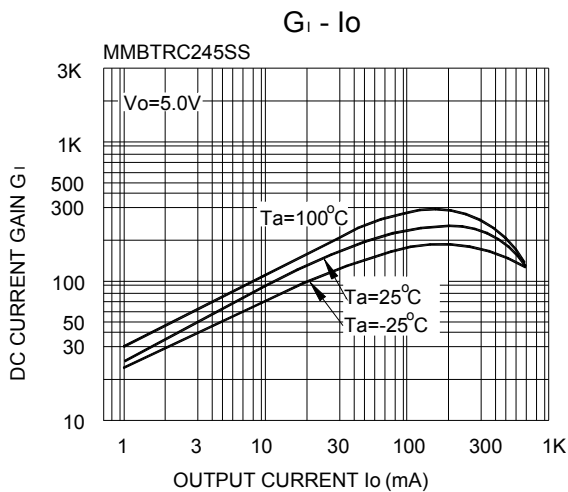
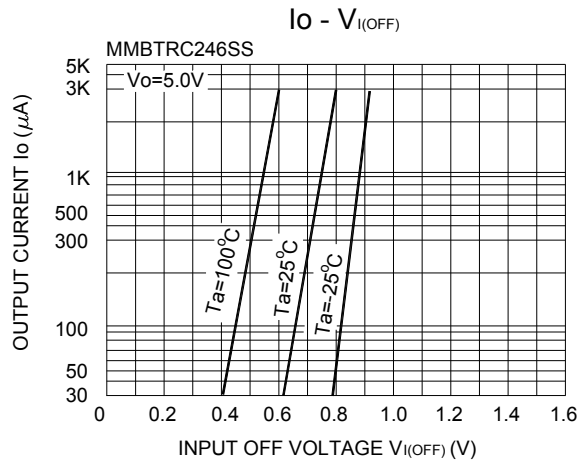
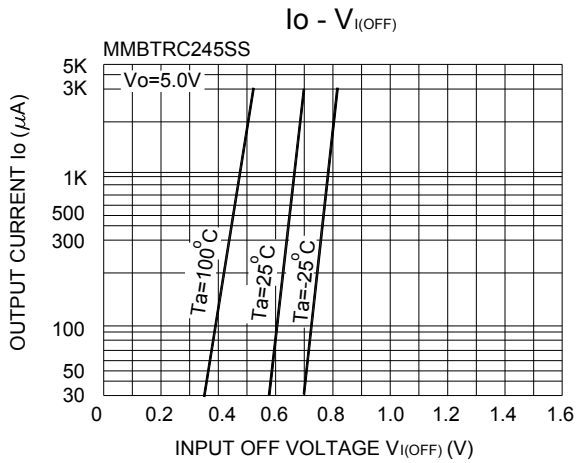
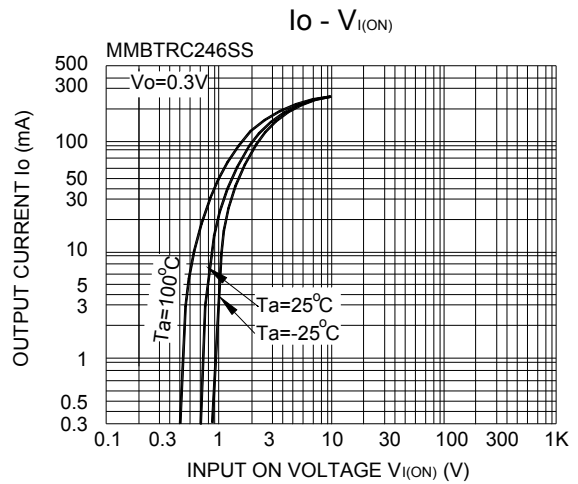
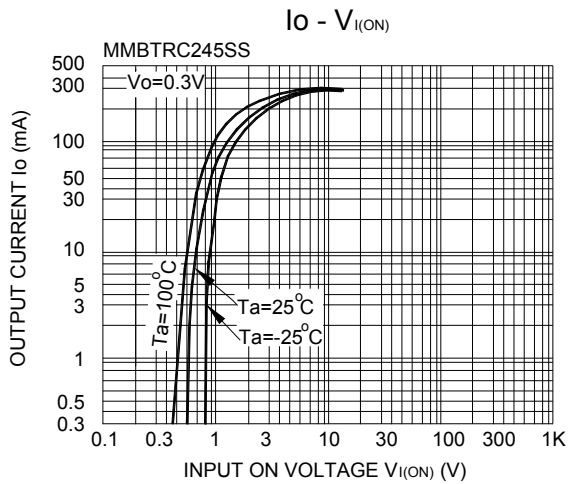

SEMTECH ELECTRONICS LTD.



ISO/TS 18949 : 2008
Certificate No. 160713009

ISO14001 : 2004
Certificate No. 7116

ISO 9001 : 2008
Certificate No. 50719410

BS-OHSAS 18001 : 2007
Certificate No. 7116

IECQ QC 080000
Certificate No. PRC-HSPM-1463-1