



## SOT-23 Plastic-Encapsulate Transistors

**MMBT3906** TRANSISTOR (PNP)

### FEATURES

- As complementary type, the NPN transistor MMBT3904 is Recommended
- Epitaxial planar die construction

**MARKING: 2A**

**MAXIMUM RATINGS (T<sub>A</sub>=25°C unless otherwise noted)**

Symbol	Parameter	Value	Units
V <sub>CB0</sub>	Collector-Base Voltage	-40	V
V <sub>CEO</sub>	Collector-Emitter Voltage	-40	V
V <sub>EBO</sub>	Emitter-Base Voltage	-5	V
I <sub>C</sub>	Collector Current -Continuous	-0.2	A
P <sub>C</sub>	Collector Dissipation	0.2	W
R <sub>θJA</sub>	Thermal resistance junction to ambient	625	°C/W
T <sub>J</sub>	Junction Temperature	150	°C
T <sub>stg</sub>	Storage Temperature	-55~+150	°C

SOT - 23

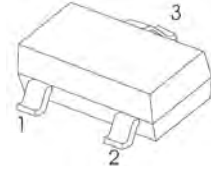

1. BASE
2. EMITTER
3. COLLECTOR

### ELECTRICAL CHARACTERISTICS (T<sub>amb</sub>=25°C unless otherwise specified)

Parameter	Symbol	Test conditions	MIN	MAX	UNIT
Collector-base breakdown voltage	V <sub>(BR)CBO</sub>	I <sub>C</sub> =-10μA, I <sub>E</sub> =0	-40		V
Collector-emitter breakdown voltage	V <sub>(BR)CEO</sub>	I <sub>C</sub> = -1mA, I <sub>B</sub> =0	-40		V
Emitter-base breakdown voltage	V <sub>(BR)EBO</sub>	I <sub>E</sub> = -10μA, I <sub>C</sub> =0	-5		V
Collector cut-off current	I <sub>CBO</sub>	V <sub>CB</sub> = -40 V, I <sub>E</sub> =0		-100	nA
Collector cut-off current	I <sub>CEX</sub>	V <sub>CE</sub> =-30V, V <sub>BE(off)</sub> =-3V		-50	nA
Emitter cut-off current	I <sub>EBO</sub>	V <sub>EB</sub> = -5V, I <sub>C</sub> =0		-100	nA
DC current gain	h <sub>FE1</sub>	V <sub>CE</sub> =-1V, I <sub>C</sub> = -10mA	100	300	
	h <sub>FE2</sub>	V <sub>CE</sub> = -1V, I <sub>C</sub> =-50mA	60		
	h <sub>FE3</sub>	V <sub>CE</sub> = -1V, I <sub>C</sub> =-100mA	30		
Collector-emitter saturation voltage	V <sub>CE(sat)1</sub>	I <sub>C</sub> =-50mA, I <sub>B</sub> =-5mA		-0.3	V
Base-emitter saturation voltage	V <sub>BE(sat)</sub>	I <sub>C</sub> = -50mA, I <sub>B</sub> =-5mA		-0.95	V
Transition frequency	f <sub>T</sub>	V <sub>CE</sub> =-20V, I <sub>C</sub> =-10mA, f=100MHz	300		MHz
Delay Time	td	V <sub>CC</sub> =-3V, V <sub>BE</sub> =-0.5V I <sub>C</sub> =-10mA, I <sub>B1</sub> =I <sub>B2</sub> =-1mA		35	nS
Rise Time	tr			35	nS
Storage Time	ts	V <sub>CC</sub> =-3V, I <sub>C</sub> =-10mA I <sub>B1</sub> =I <sub>B2</sub> =-1mA		225	nS
Fall Time	tf			75	nS

### CLASSIFICATION OF h<sub>FE(1)</sub>

HFE	100-300	
RANK	L	H
RANGE	100 - 200	200 - 300

# Typical Characteristics

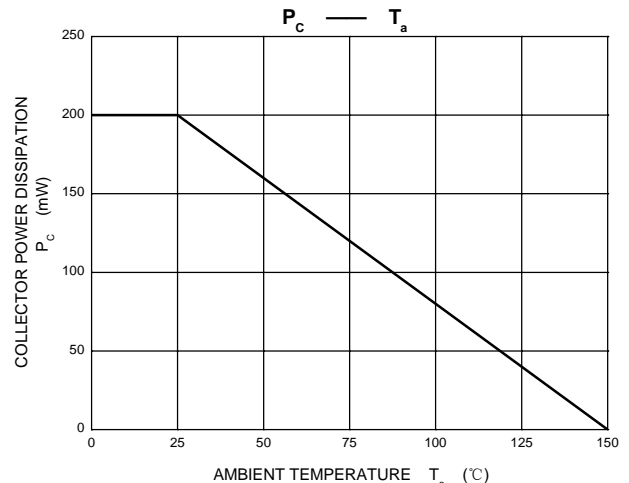
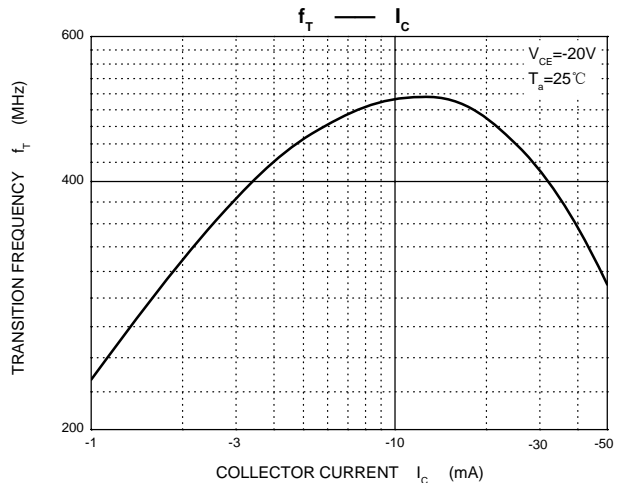
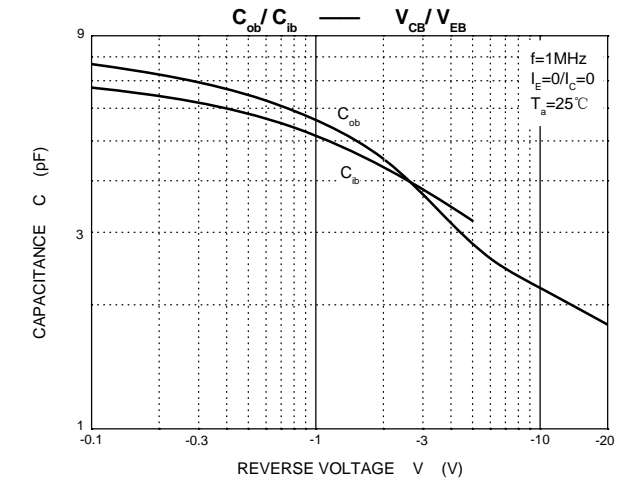
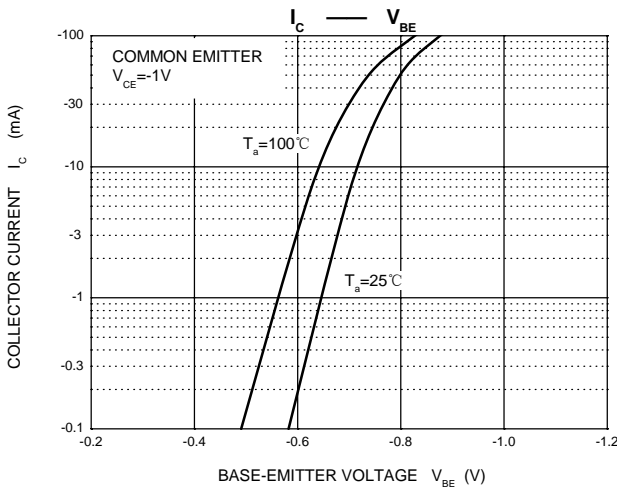
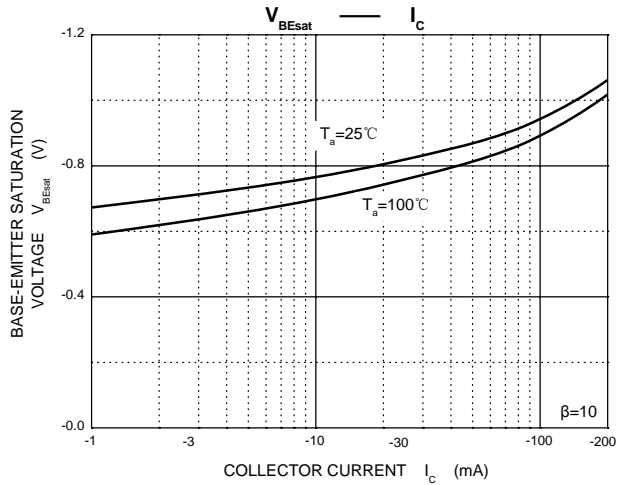
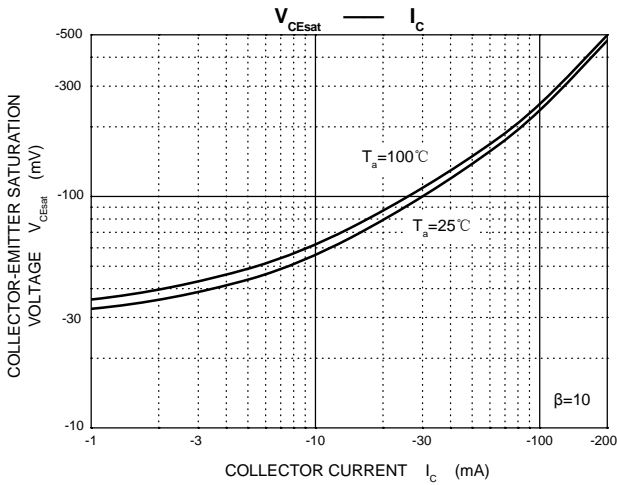
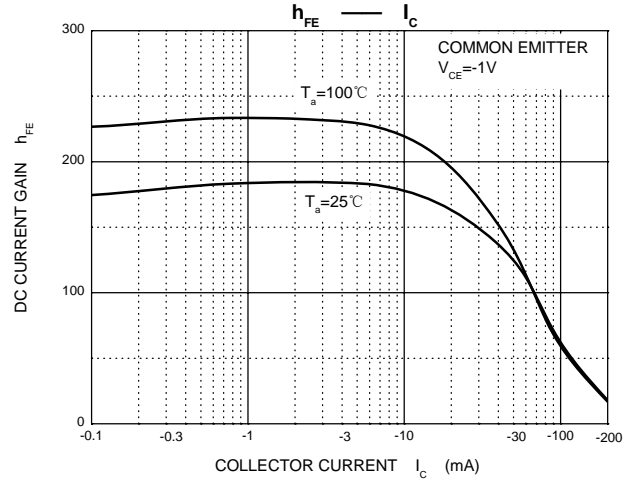
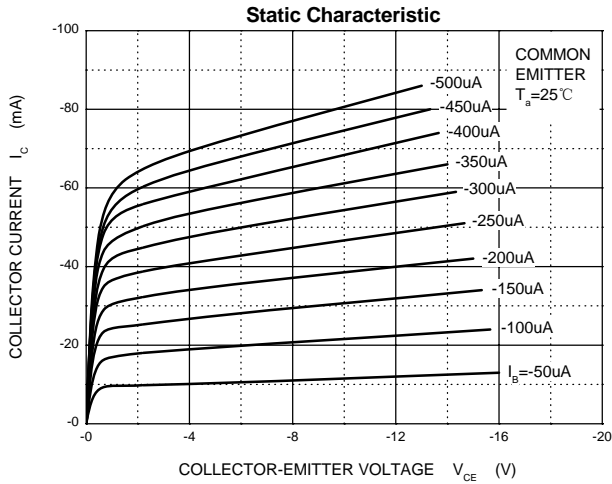

## SOT-23 Package Outline Dimensions

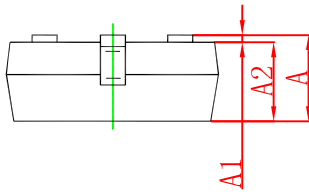
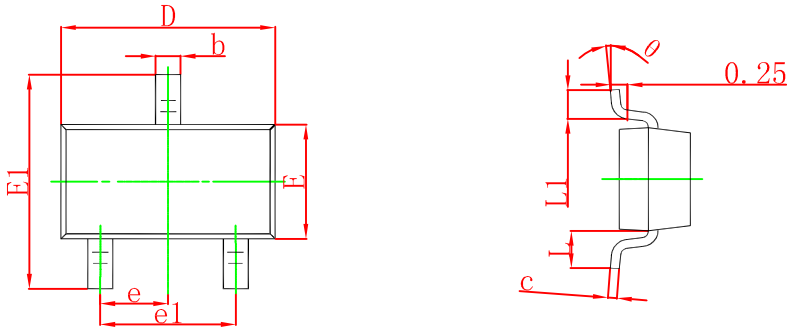

Symbol	Dimensions In Millimeters		Dimensions In Inches	
	Min	Max	Min	Max
A	0.900	1.150	0.035	0.045
A1	0.000	0.100	0.000	0.004
A2	0.900	1.050	0.035	0.041
b	0.300	0.500	0.012	0.020
c	0.080	0.150	0.003	0.006
D	2.800	3.000	0.110	0.118
E	1.200	1.400	0.047	0.055
E1	2.250	2.550	0.089	0.100
e	0.950 TYP		0.037 TYP	
e1	1.800	2.000	0.071	0.079
L	0.550 REF		0.022 REF	
L1	0.300	0.500	0.012	0.020
θ	0°	8°	0°	8°

## SOT-23 Suggested Pad Layout



- Note:
1. Controlling dimension: in millimeters.
  2. General tolerance:  $\pm 0.05\text{mm}$ .
  3. The pad layout is for reference purposes only.

### NOTICE

JCET reserve the right to make modifications, enhancements, improvements, corrections or other changes without further notice to any product herein. JCET does not assume any liability arising out of the application or use of any product described herein.

# SOT-23 Tape and Reel

## SOT-23 Embossed Carrier Tape

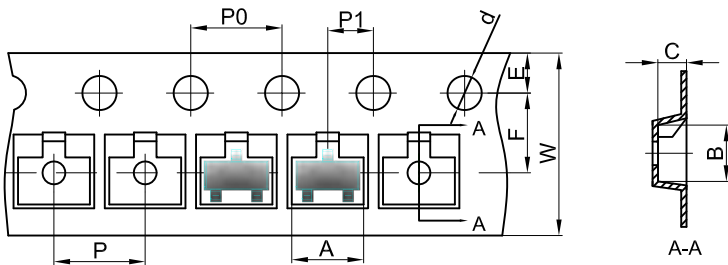

**Packaging Description:**  
 SOT-23 parts are shipped in tape. The carrier tape is made from a dissipative (carbon filled) polycarbonate resin. The cover tape is a multilayer film (Heat Activated Adhesive in nature) primarily composed of polyester film, adhesive layer, sealant, and anti-static sprayed agent. These reeled parts in standard option are shipped with 3,000 units per 7" or 17.8cm diameter reel. The reels are clear in color and is made of polystyrene plastic (anti-static coated).

Dimensions are in millimeter										
Pkg type	A	B	C	d	E	F	P0	P	P1	W
SOT-23	3.15	2.77	1.22	Ø1.50	1.75	3.50	4.00	4.00	2.00	8.00

## SOT-23 Tape Leader and Trailer

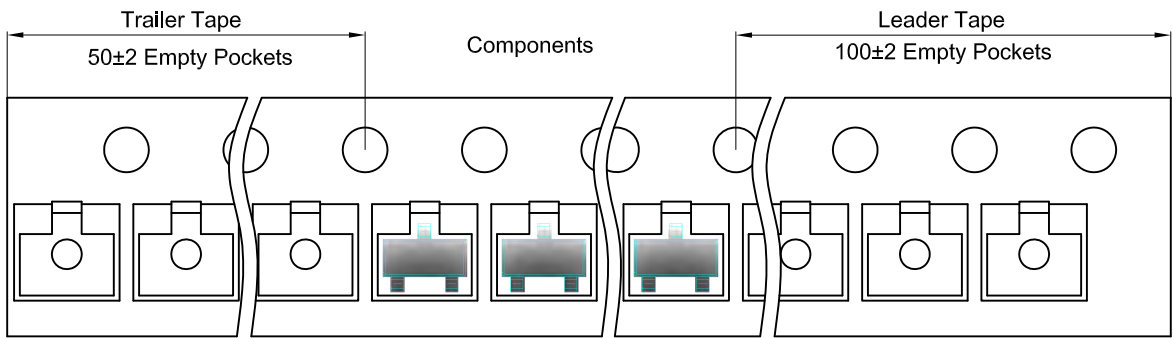

## SOT-23 Reel(S)

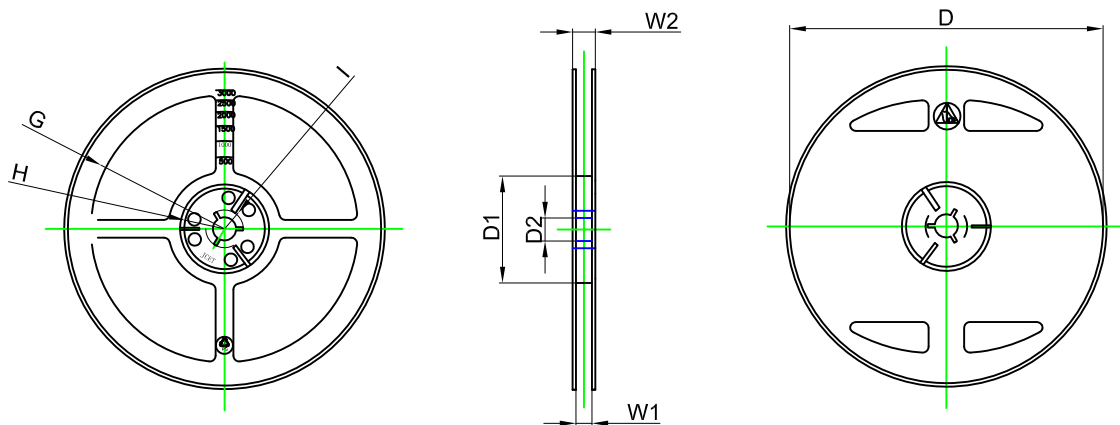

Dimensions are in millimeter								
Reel Option	D	D1	D2	G	H	I	W1	W2
7" Dia	Ø178.00	54.40	13.00	R78.00	R25.60	R9.35	9.50	12.00

REEL	Reel Size	Box	Box Size(mm)	Carton	Carton Size(mm)	G.W.(kg)
3000 pcs	7 inch	45,000 pcs	203×203×195	180,000 pcs	438×438×220	