

L2N7002KLT1G

S-L2N7002KLT1G

Small Signal MOSFET
380 mAmps, 60 Volts N-Channel SOT-23

1. FEATURES

- We declare that the material of product compliance with RoHS requirements and Halogen Free.
- S- prefix for automotive and other applications requiring unique site and control change requirements; AEC-Q101 qualified and PPAP capable.
- ESD Protected

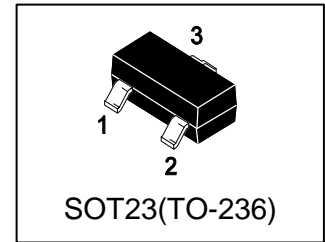

2. DEVICE MARKING AND ORDERING INFORMATION

Device	Marking	Shipping
L2N7002KLT1G	RK	3000/Tape&Reel
L2N7002KLT3G	RK	10000/Tape&Reel

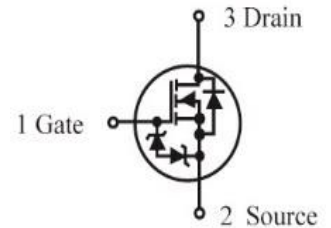

3. MAXIMUM RATINGS(Ta = 25°C)

Parameter	Symbol	Limits	Unit
Drain-Source Voltage	VDSS	60	Vdc
Gate-Source Voltage	VGS	±20	Vdc
Drain Current	ID		mAdc
– Steady State TA = 25°C		320	
TA = 85°C		230	
– t<5s TA = 25°C		380	
TA = 85°C		270	
Pulsed Drain Current (tp=10µs)	IDM	1.5	A
Source Current (Body Diode)	IS	300	mA

4. THERMAL CHARACTERISTICS

Parameter	Symbol	Limits	Unit
Total Device Dissipation(Note 1)	PD		mW
– Steady State		300	
– t<5s		420	
Junction-to-Ambient(Note 1)	RθJA		°C/W
– Steady State		417	
– t<5s		300	
Lead Temperature for Soldering Purposes (1/8 " from case for 10 s)	TL	260	°C
Junction and Storage temperature	TJ,Tstg	-55~+150	°C
Gate-Source ESD Rating(HBM, Method 3015)	ESD	2000	V

1. FR-5 = 1.0×0.75×0.062 in.

5. ELECTRICAL CHARACTERISTICS (Ta= 25°C)
OFF CHARACTERISTICS

Characteristic	Symbol	Min.	Typ.	Max.	Unit
Drain-Source Breakdown Voltage (VGS = 0, ID = 250μAdc)	VBRDSS	60	-	-	Vdc
Drain-to-Source Breakdown Voltage Temperature Coefficient	VBRDSS/TJ	-	71	-	mV/°C
Zero Gate Voltage Drain Current (VGS = 0, VDS = 60 Vdc)	IDSS	TJ = 25°C	-	1.0	μAdc
		TJ = 125°C	-	500	
(VGS = 0, VDS = 50 Vdc) TJ = 25°C		-	-	100	nAdc
Gate-Body Leakage Current, Forward (VGS = 20 Vdc)	IGSSF	-	-	10	μAdc
Gate-Body Leakage Current, Reverse (VGS = - 20 Vdc)	IGSSR	-	-	-10	μAdc

ON CHARACTERISTICS (Note 2)

Characteristic	Symbol	Min.	Typ.	Max.	Unit
Gate Threshold Voltage (VDS = VGS, ID = 250μAdc)	VGS(th)	1.0	-	2.5	Vdc
Negative Threshold Temperature Coefficient	VGS(TH)/TJ	-	4	-	mV/°C
Static Drain-Source On-State Resistance (VGS = 10 Vdc, ID = 500 mAdc)	RDS(on)	-	-	2.3	Ohm
		(VGS = 5.0 Vdc, ID = 50 mAdc)	-	-	
Forward Transconductance (VDS = 5.0 Vdc, ID = 200 mAdc)	gfs	80	-	-	mS

DYNAMIC CHARACTERISTICS

Characteristic	Symbol	Min.	Typ.	Max.	Unit
Total Gate Charge (VDS = 10V, VGS = 4.5V, ID = 0.5A)	Qg	-	360	-	pC
Gate-Source Charge (VDS = 10V, VGS = 4.5V, ID = 0.5A)	Qgs	-	90	-	
Gate-Drain Charge (VDS = 10V, VGS = 4.5V, ID = 0.5A)	Qgd	-	210	-	
Input Capacitance (VDS = 25 Vdc, VGS = 0, f = 1.0 MHz)	Ciss	-	34	-	pF
Output Capacitance (VDS = 25 Vdc, VGS = 0, f = 1.0 MHz)	Coss	-	3	-	pF
Reverse Transfer Capacitance (VDS = 25 Vdc, VGS = 0, f = 1.0 MHz)	Crss	-	2.2	-	pF

SWITCHING CHARACTERISTICS

Characteristic	Symbol	Min.	Typ.	Max.	Unit
Turn-On Delay Time	td(on)	-	3.8	-	ns
Rise Time	tr	-	3.4	-	
Turn-Off Delay Time	td(off)	-	19	-	
Fall Time	tf	-	12	-	

VDS = 10 V, VGEN = 10 V,
ID = 500 mA

BODY-DRAIN DIODE RATINGS

Characteristic	Symbol	Min.	Typ.	Max.	Unit
Diode Forward On-Voltage (IS = 115 mAdc, VGS = 0 V)	VSD	TJ = 25°C	-	1.4	Vdc
		TJ = 85°C	-	0.7	

2.Pulse Test: Pulse Width ≤300 μs, Duty Cycle ≤2.0%.

6. ELECTRICAL CHARACTERISTICS CURVES

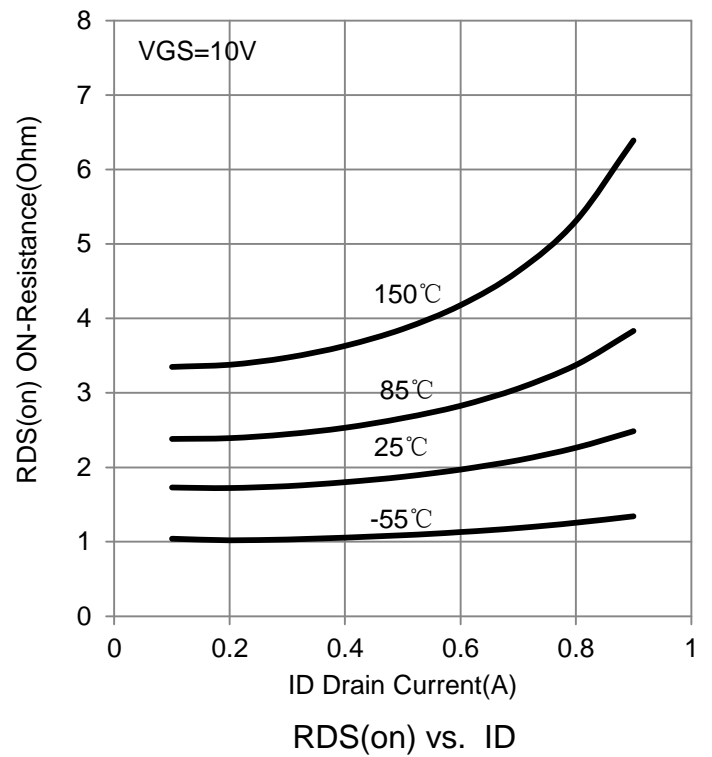
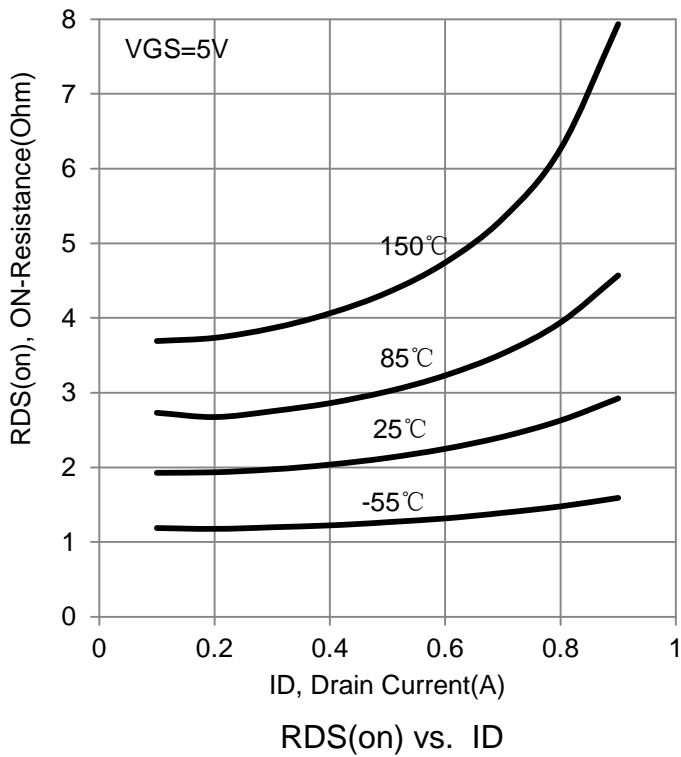
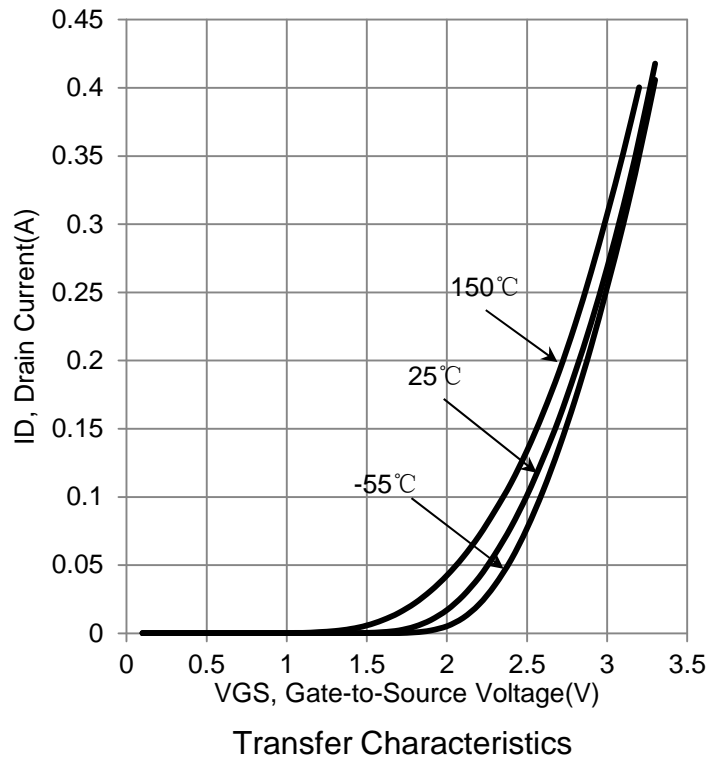
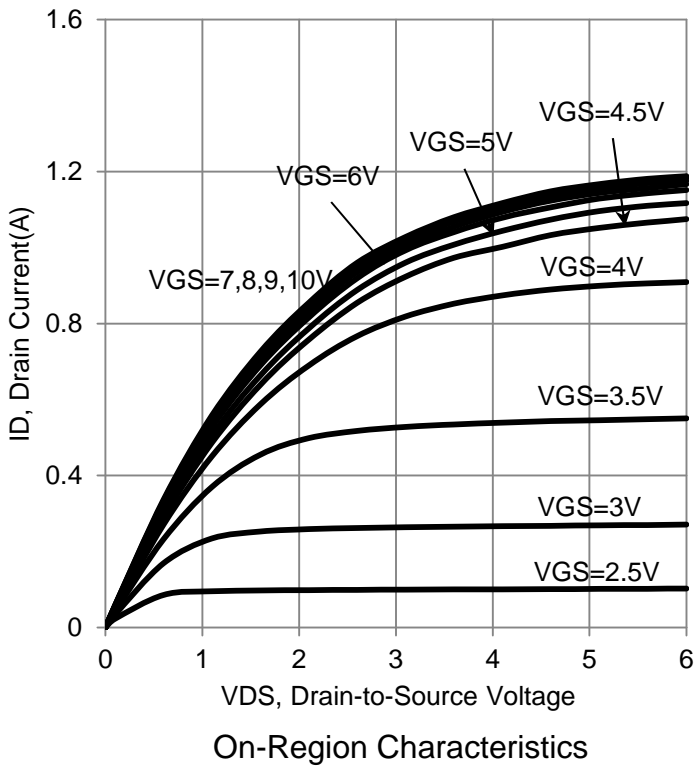

6. ELECTRICAL CHARACTERISTICS CURVES (Con.)

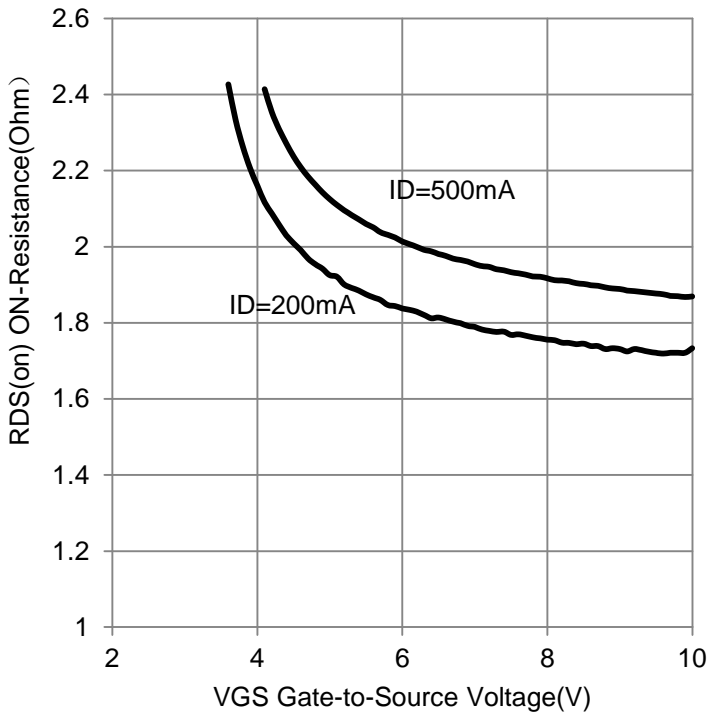

RDS(on) vs. VGS

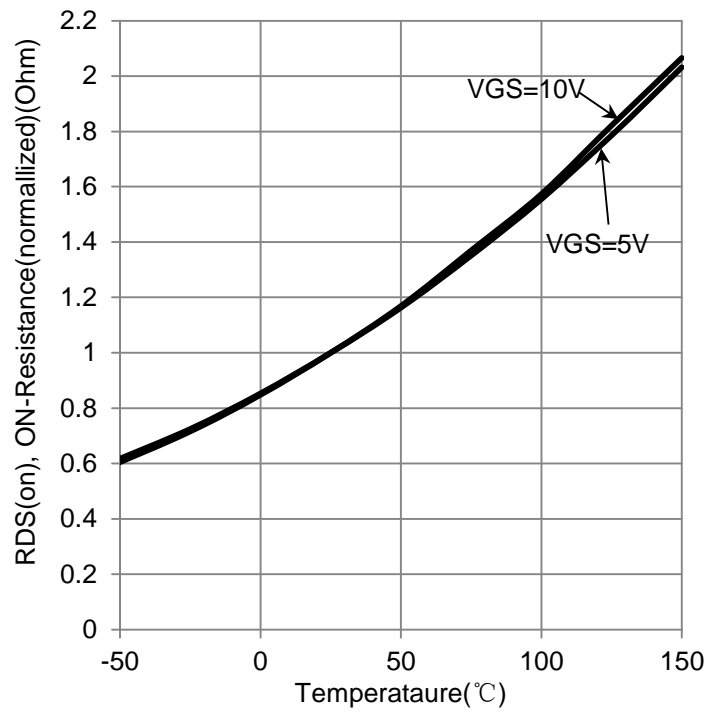

RDS(on) vs. Temperature

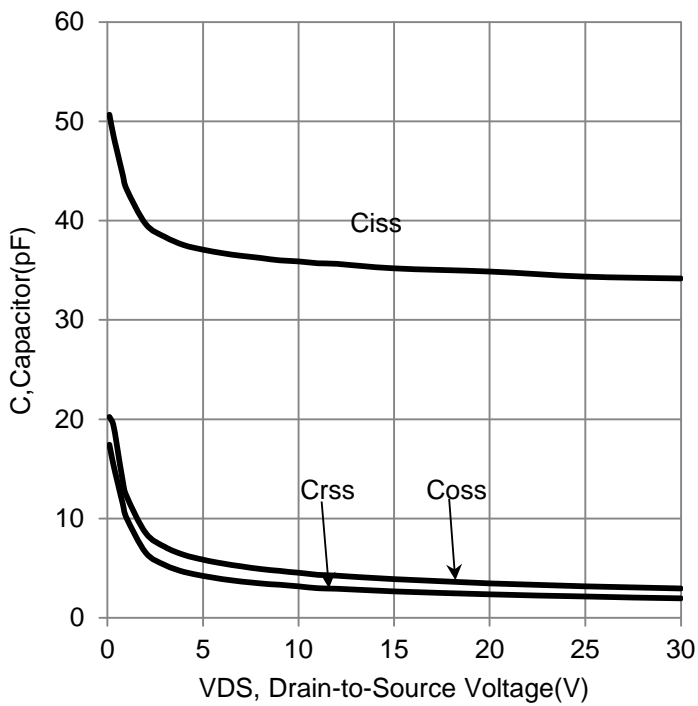

Capacitor vs. VDS

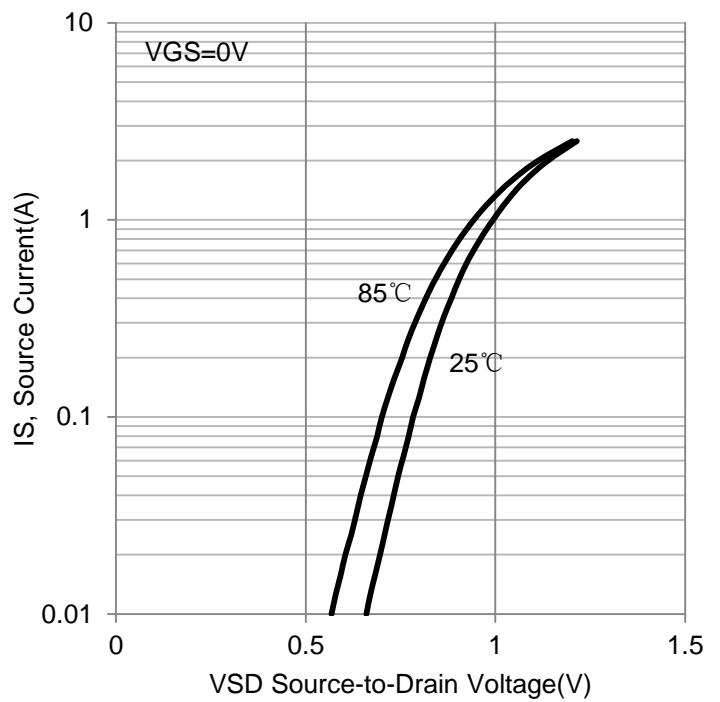

I_S vs. VSD

6. ELECTRICAL CHARACTERISTICS CURVES (Con.)

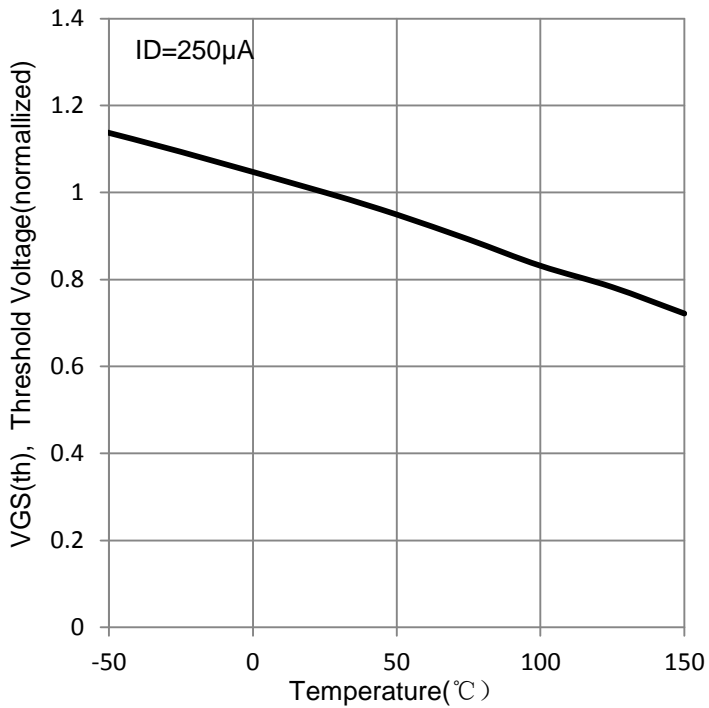

VGS(th) vs. Temperature

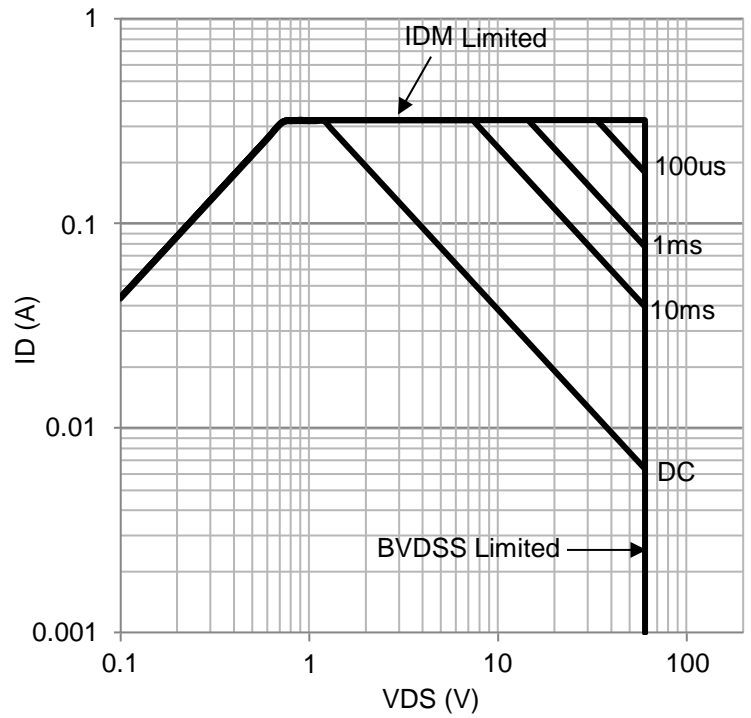

Safe Operating Area

7.OUTLINE AND DIMENSIONS

Notes:

1. DIMENSIONING AND TOLERANCING PER ANSI Y14.5M, 1982.
2. CONTROLLING DIMENSION: MILLIMETERS.
3. MAXIMUM LEAD THICKNESS INCLUDES LEAD FINISH. MINIMUM LEAD THICKNESS IS THE MINIMUM THICKNESS OF BASE MATERIAL.
4. DIMENSIONS D AND E DO NOT INCLUDE MOLD FLASH, PROTRUSIONS OR GATE BURRS.

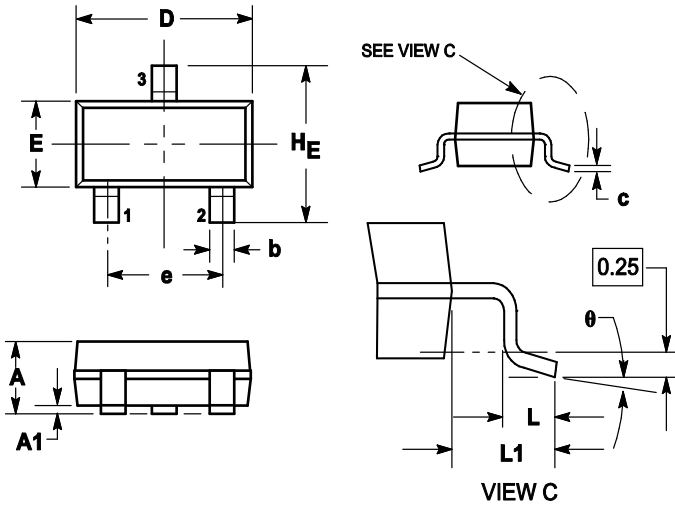

DIM	MILLIMETERS			INCHES		
	MIN	NOM	MAX	MIN	NOM	MAX
A	0.89	1	1.11	0.035	0.04	0.044
A1	0.01	0.06	0.1	0.001	0.002	0.004
b	0.37	0.44	0.5	0.015	0.018	0.02
c	0.09	0.13	0.18	0.003	0.005	0.007
D	2.80	2.9	3.04	0.11	0.114	0.12
E	1.20	1.3	1.4	0.047	0.051	0.055
e	1.78	1.9	2.04	0.07	0.075	0.081
L	0.10	0.2	0.3	0.004	0.008	0.012
L1	0.35	0.54	0.69	0.014	0.021	0.029
HE	2.10	2.4	2.64	0.083	0.094	0.104
θ	0°	---	10°	0°	---	10°

8.SOLDERING FOOTPRINT

