



# SOT-89-3L Plastic-Encapsulate Transistors

**KTA1664**

TRANSISTOR (PNP)

**FEATURES**

- Complementary to KTC4376
- Small Flat Package
- High Current Application

SOT-89-3L

- 1. BASE
- 2. COLLECTOR
- 3. EMITTER

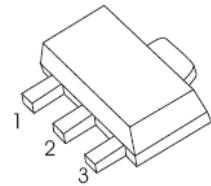

**MAXIMUM RATINGS (T<sub>a</sub>=25°C unless otherwise noted)**

| Symbol           | Parameter                                   | Value    | Unit |
|------------------|---|----------|------|
| V <sub>CB0</sub> | Collector-Base Voltage                      | -35      | V    |
| V <sub>CEO</sub> | Collector-Emitter Voltage                   | -30      | V    |
| V <sub>EBO</sub> | Emitter-Base Voltage                        | -5       | V    |
| I <sub>C</sub>   | Collector Current                           | -800     | mA   |
| P <sub>C</sub>   | Collector Power Dissipation                 | 500      | mW   |
| R <sub>θJA</sub> | Thermal Resistance From Junction To Ambient | 250      | °C/W |
| T <sub>j</sub>   | Junction Temperature                        | 150      | °C   |
| T <sub>stg</sub> | Storage Temperature                         | -55~+150 | °C   |

**ELECTRICAL CHARACTERISTICS (T<sub>a</sub>=25°C unless otherwise specified)**

| Parameter                            | Symbol               | Test conditions                                  | Min  | Typ | Max  | Unit |
|--------------------------------------|----------------------|--|------|-----|------|------|
| Collector-base breakdown voltage     | V <sub>(BR)CBO</sub> | I <sub>C</sub> = -1mA, I <sub>E</sub> =0         | -35  |     |      | V    |
| Collector-emitter breakdown voltage  | V <sub>(BR)CEO</sub> | I <sub>C</sub> =-10mA, I <sub>B</sub> =0         | -30  |     |      | V    |
| Emitter-base breakdown voltage       | V <sub>(BR)EBO</sub> | I <sub>E</sub> =-1mA, I <sub>C</sub> =0          | -5   |     |      | V    |
| Collector cut-off current            | I <sub>CB0</sub>     | V <sub>CB</sub> =-35V, I <sub>E</sub> =0         |      |     | -100 | nA   |
| Emitter cut-off current              | I <sub>EBO</sub>     | V <sub>EB</sub> =-5V, I <sub>C</sub> =0          |      |     | -100 | nA   |
| DC current gain                      | h <sub>FE</sub>      | V <sub>CE</sub> =-1V, I <sub>C</sub> =-100mA     | 100  |     | 320  |      |
|                                      |                      | V <sub>CE</sub> =-1V, I <sub>C</sub> =-700mA     | 35   |     |      |      |
| Collector-emitter saturation voltage | V <sub>CE(sat)</sub> | I <sub>C</sub> =-500mA, I <sub>B</sub> =-20mA    |      |     | -0.7 | V    |
| Base-emitter voltage                 | V <sub>BE</sub>      | V <sub>CE</sub> =-1V, I <sub>C</sub> =-10mA      | -0.5 |     | -0.8 | V    |
| Collector output capacitance         | C <sub>ob</sub>      | V <sub>CB</sub> =-10V, I <sub>E</sub> =0, f=1MHz |      | 19  |      | pF   |
| Transition frequency                 | f <sub>T</sub>       | V <sub>CE</sub> =-5V, I <sub>C</sub> = -10mA     |      | 120 |      | MHz  |

**CLASSIFICATION OF h<sub>FE</sub>**

| RANK    | O         | Y         |
|---------|-----------|-----------|
| RANGE   | 100 - 200 | 160 - 320 |
| MARKING | RO        | RY        |

# Typical Characteristics

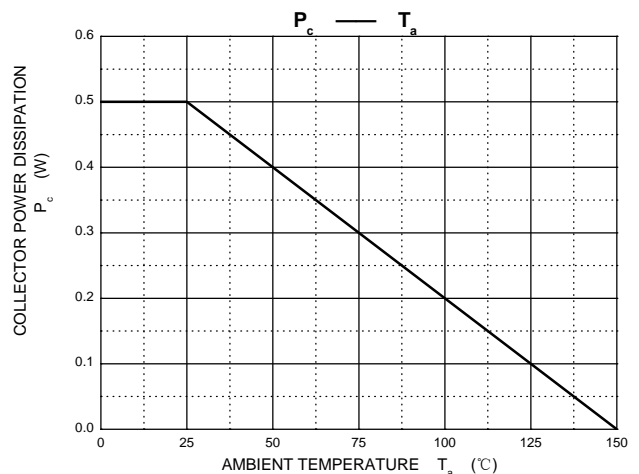
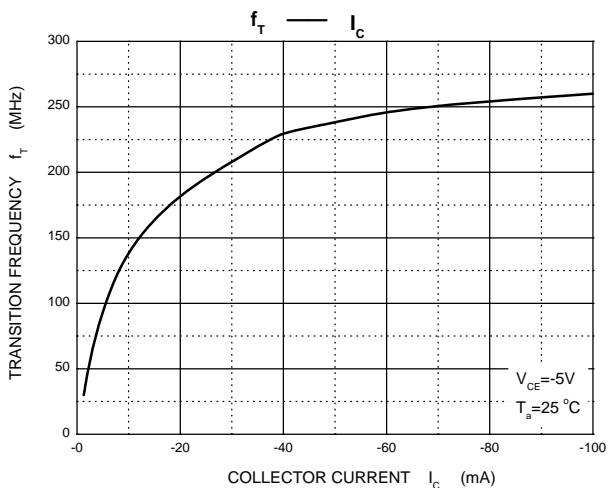
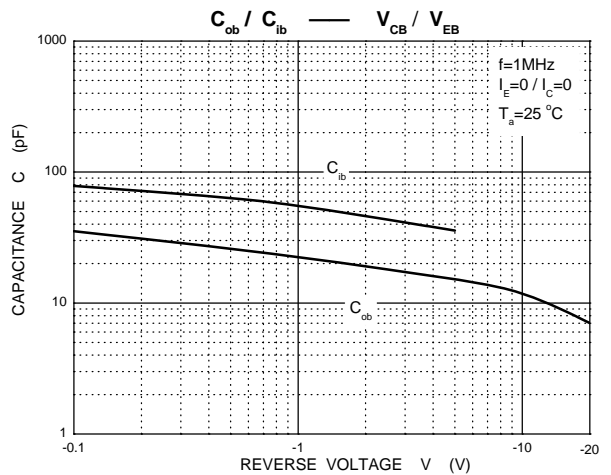
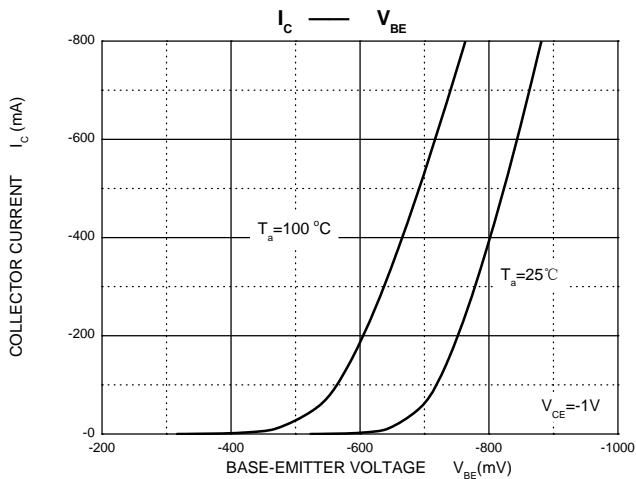
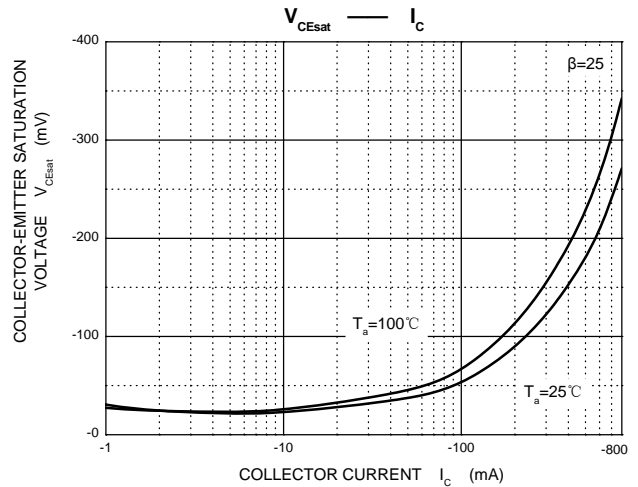
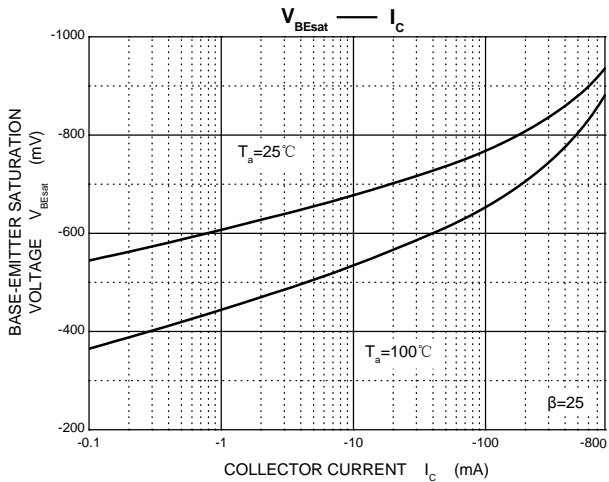
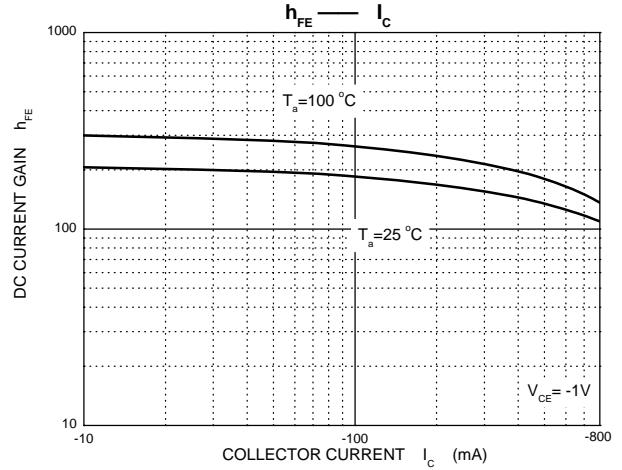
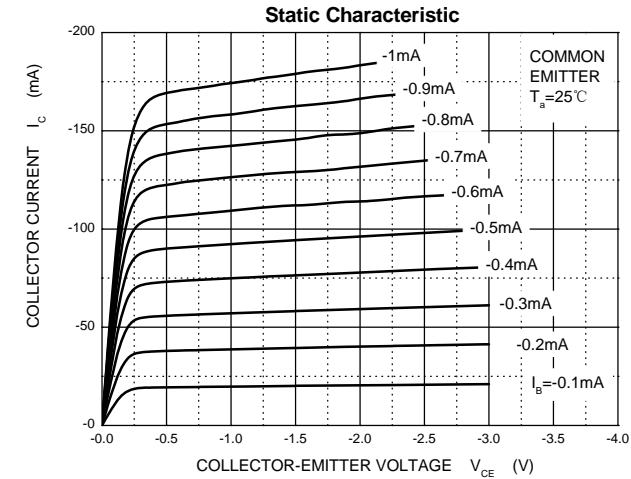

## SOT-89-3L Package Outline Dimensions

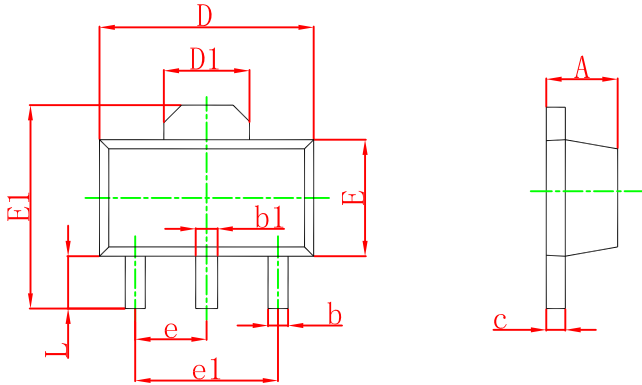

| Symbol | Dimensions In Millimeters |       | Dimensions In Inches |       |
|--------|---------------------------|-------|----------------------|-------|
|        | Min                       | Max   | Min                  | Max   |
| A      | 1.400                     | 1.600 | 0.055                | 0.063 |
| b      | 0.320                     | 0.520 | 0.013                | 0.020 |
| b1     | 0.400                     | 0.580 | 0.016                | 0.023 |
| c      | 0.350                     | 0.440 | 0.014                | 0.017 |
| D      | 4.400                     | 4.600 | 0.173                | 0.181 |
| D1     | 1.550 REF.                |       | 0.061 REF.           |       |
| E      | 2.300                     | 2.600 | 0.091                | 0.102 |
| E1     | 3.940                     | 4.250 | 0.155                | 0.167 |
| e      | 1.500 TYP.                |       | 0.060 TYP.           |       |
| e1     | 3.000 TYP.                |       | 0.118 TYP.           |       |
| L      | 0.900                     | 1.200 | 0.035                | 0.047 |

## SOT-89-3L Suggested Pad Layout

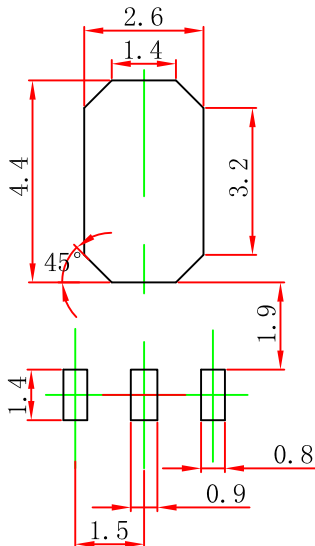

- Note:
1. Controlling dimension: in millimeters.
  2. General tolerance:  $\pm 0.05$  mm.
  3. The pad layout is for reference purposes only.

### NOTICE

JCET reserve the right to make modifications, enhancements, improvements, corrections or other changes without further notice to any product herein. JCET does not assume any liability arising out of the application or use of any product described herein.

# SOT-89-3L Tape and Reel

## SOT-89-3L Embossed Carrier Tape



**Packaging Description:**  
 SOT-89-3L parts are shipped in tape. The carrier tape is made from a dissipative (carbon filled) polycarbonate resin. The cover tape is a multilayer film (Heat Activated Adhesive in nature) primarily composed of polyester film, adhesive layer, sealant, and anti-static sprayed agent. These reeled parts in standard option are shipped with 1,000 units per 7" or 18.0 cm diameter reel. The reels are clear in color and is made of polystyrene plastic (anti-static coated).

| Dimensions are in millimeter |      |      |      |       |      |      |      |      |      |       |
|------------------------------|------|------|------|-------|------|------|------|------|------|-------|
| Pkg type                     | A    | B    | C    | d     | E    | F    | P0   | P    | P1   | W     |
| SOT-89-3L                    | 4.85 | 4.45 | 1.85 | Ø1.50 | 1.75 | 5.50 | 4.00 | 8.00 | 2.00 | 12.00 |

## SOT-89-3L Tape Leader and Trailer

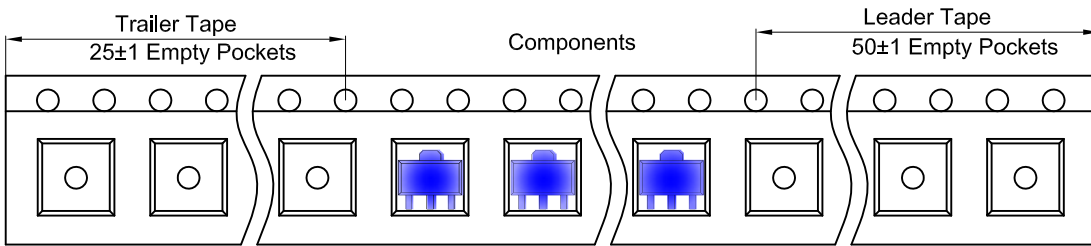

## SOT-89-3L Reel

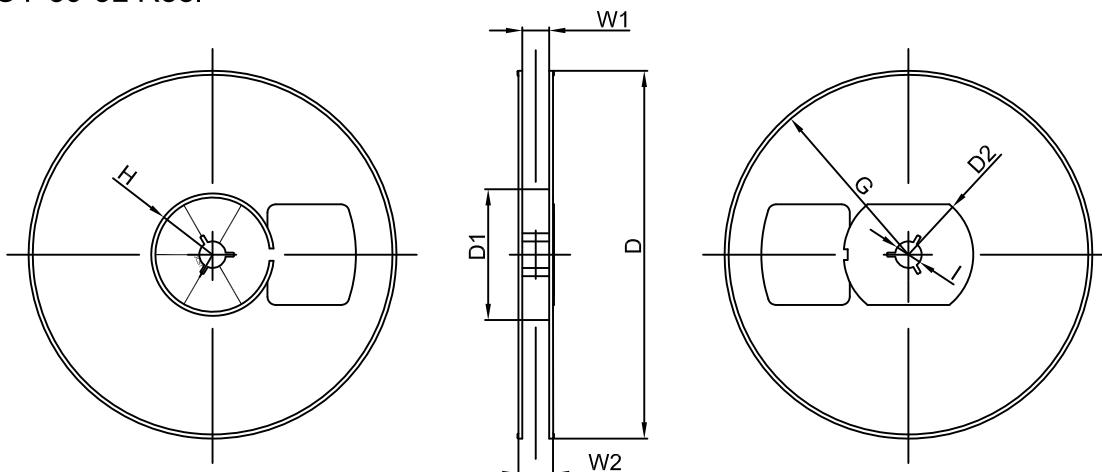

| Dimensions are in millimeter |         |       |        |        |        |        |       |       |
|------------------------------|---------|-------|--------|--------|--------|--------|-------|-------|
| Reel Option                  | D       | D1    | D2     | G      | H      | I      | W1    | W2    |
| 7" Dia                       | Ø180.00 | 60.00 | R32.00 | R86.50 | R30.00 | Ø13.00 | 13.20 | 16.50 |

| REEL     | Reel Size | Box        | Box Size(mm) | Carton     | Carton Size(mm) | G.W.(kg) |
|----------|-----------|------------|--------------|------------|-----------------|----------|
| 1000 pcs | 7 inch    | 10,000 pcs | 203×203×195  | 40,000 pcs | 438×438×220     |          |