

## TO-220F Plastic-Encapsulate Transistors

### KSD1408 TRANSISTOR (NPN)

#### FEATURES

- Low Frequency Amplifier
- Medium Speed Switching

#### MAXIMUM RATINGS ( $T_a=25^{\circ}\text{C}$ unless otherwise noted)

Symbol	Parameter	Value	Unit
$V_{CB0}$	Collector-Base Voltage	80	V
$V_{CE0}$	Collector-Emitter Voltage	80	V
$V_{EB0}$	Emitter-Base Voltage	5	V
$I_C$	Collector Current	4	A
$P_C$	Collector Power Dissipation	2	W
$R_{\theta JA}$	Thermal Resistance From Junction To Ambient	62.5	$^{\circ}\text{C}/\text{W}$
$T_j$	Junction Temperature	150	$^{\circ}\text{C}$
$T_{stg}$	Storage Temperature	-55~+150	$^{\circ}\text{C}$

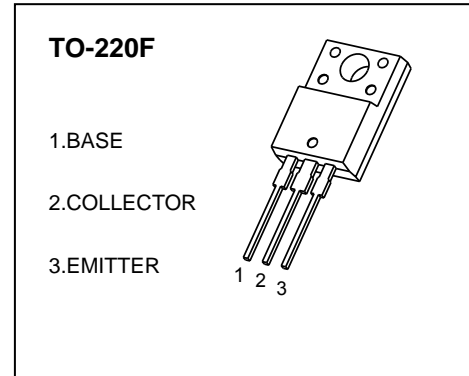

#### ELECTRICAL CHARACTERISTICS ( $T_a=25^{\circ}\text{C}$ unless otherwise specified)

Parameter	Symbol	Test conditions	Min	Typ	Max	Unit
Collector-base breakdown voltage	$V_{(BR)CB0}$	$I_C=100\mu\text{A}, I_E=0$	80			V
Collector-emitter breakdown voltage	$V_{(BR)CE0}$	$I_C=50\text{mA}, I_B=0$	80			V
Emitter-base breakdown voltage	$V_{(BR)EB0}$	$I_E=100\mu\text{A}, I_C=0$	5			V
Collector cut-off current	$I_{CB0}$	$V_{CB}=80\text{V}, I_E=0$			30	$\mu\text{A}$
Emitter cut-off current	$I_{EB0}$	$V_{EB}=5\text{V}, I_C=0$			100	$\mu\text{A}$
DC current gain	$h_{FE(1)}$	$V_{CE}=5\text{V}, I_C=0.5\text{A}$	40		240	
	$h_{FE(2)}$	$V_{CE}=5\text{V}, I_C=3\text{A}$	15			
Collector-emitter saturation voltage	$V_{CE(sat)}$	$I_C=3\text{A}, I_B=0.3\text{A}$			1.5	V
Base-emitter voltage	$V_{BE}$	$V_{CE}=5\text{V}, I_C=3\text{A}$			1.5	V
Transition frequency	$f_T$	$V_{CE}=5\text{V}, I_C=0.5\text{A}$		8		MHz
Collector output capacitance	$C_{ob}$	$V_{CB}=10\text{V}, I_E=0, f=1\text{MHz}$		90		pF

\*Pulse test: pulse width  $\leq 300\mu\text{s}$ , duty cycles  $\leq 2.0\%$ .

#### CLASSIFICATION OF $h_{FE(1)}$

RANK	R	O	Y
RANGE	40-80	70-140	120-240

# Typical Characteristics

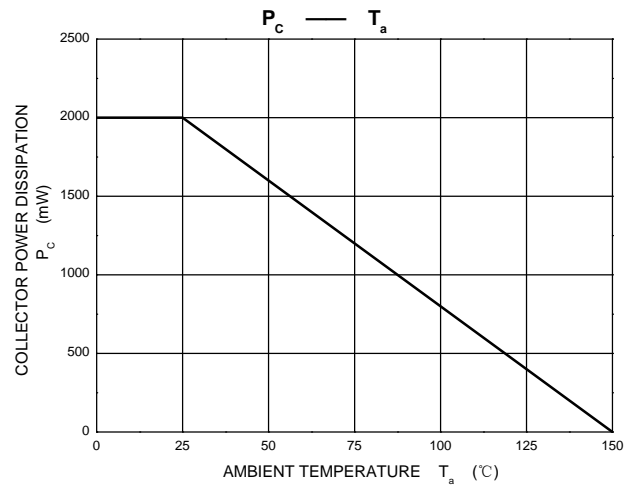
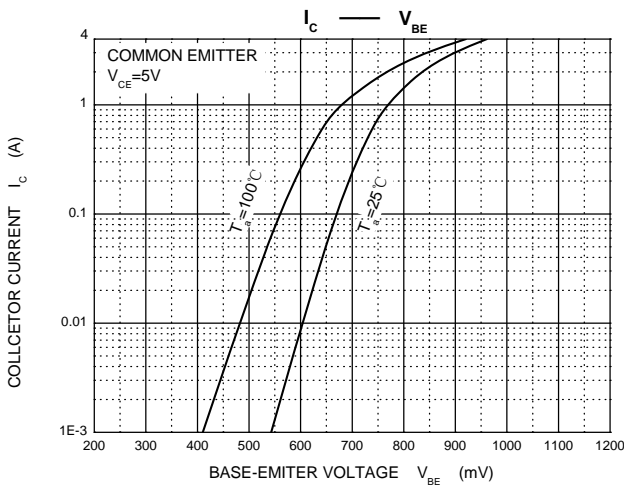
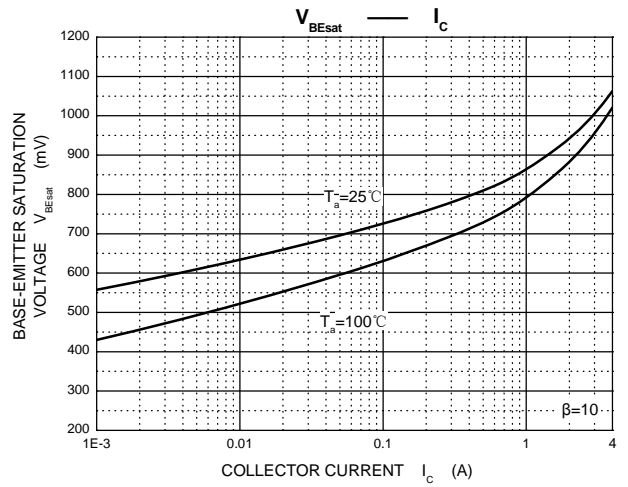
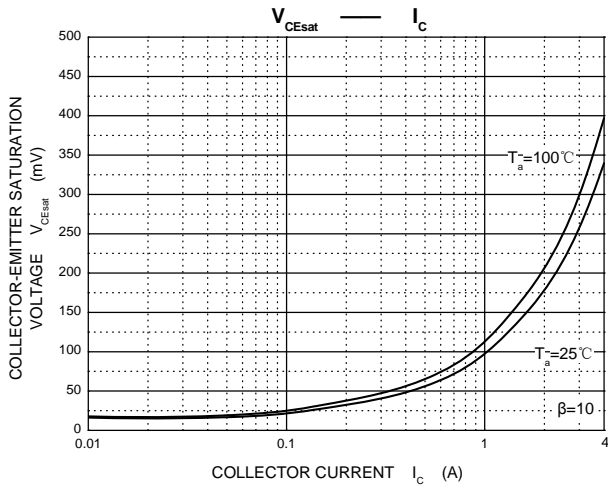
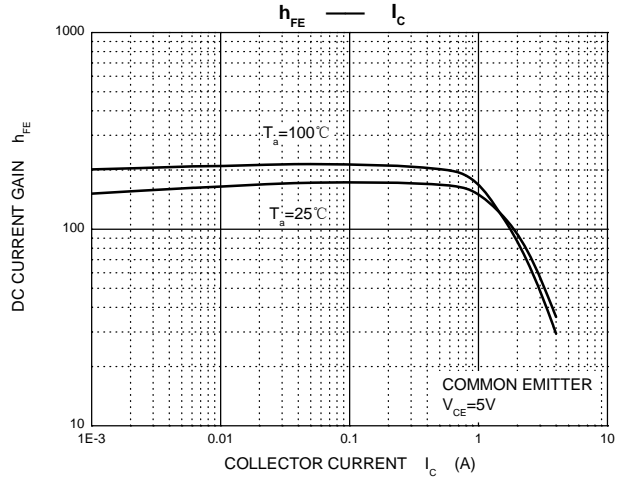
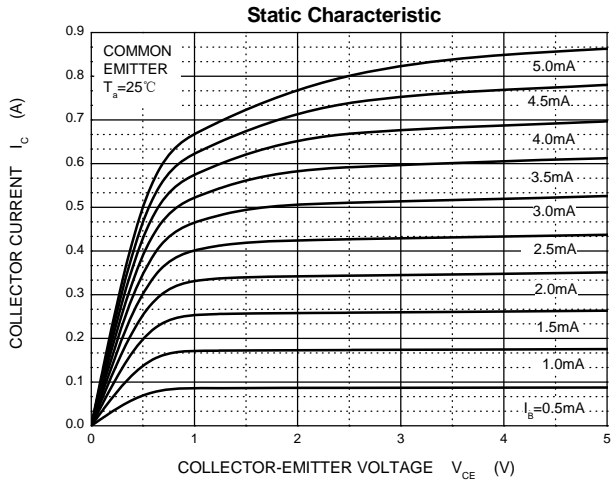

# TO-220F Package Outline Dimensions

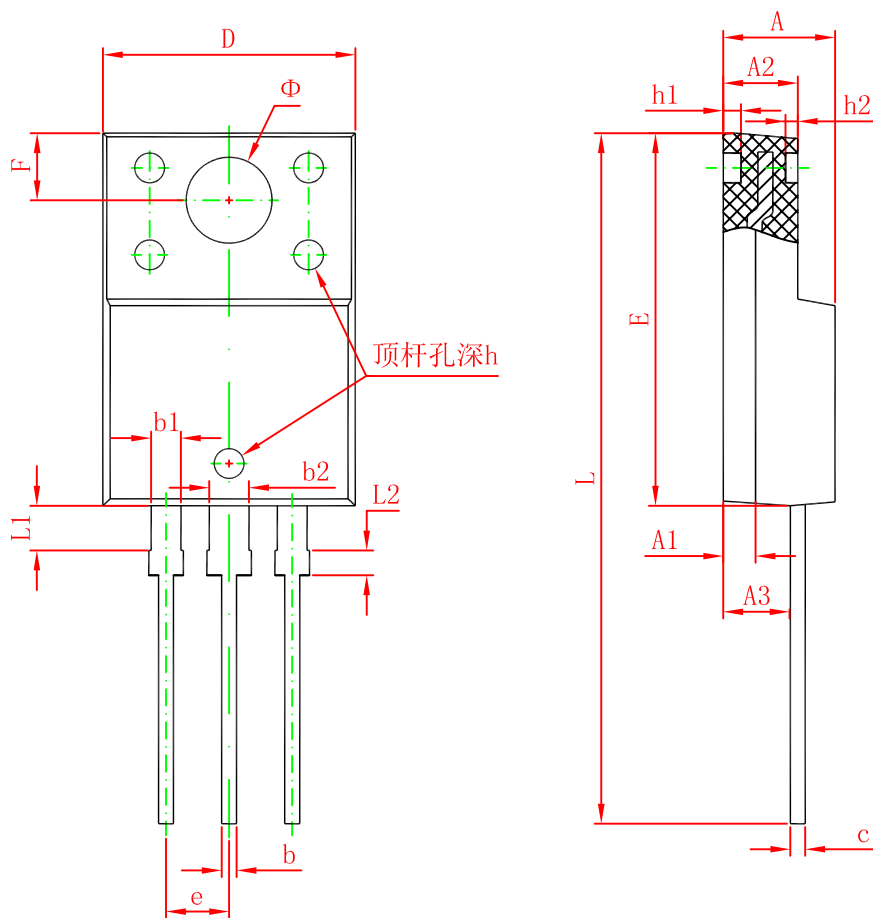

Symbol	Dimensions In Millimeters		Dimensions In Inches	
	Min.	Max.	Min.	Max.
A	4.300	4.700	0.169	0.185
A1	1.300 REF.		0.051 REF.	
A2	2.800	3.200	0.110	0.126
A3	2.500	2.900	0.098	0.114
b	0.500	0.750	0.020	0.030
b1	1.100	1.350	0.043	0.053
b2	1.500	1.750	0.059	0.069
c	0.500	0.750	0.020	0.030
D	9.960	10.360	0.392	0.408
E	14.800	15.200	0.583	0.598
e	2.540 TYP.		0.100 TYP.	
F	2.700 REF.		0.106 REF.	
Φ	3.500 REF.		0.138 REF.	
h	0.000	0.300	0.000	0.012
h1	0.800 REF.		0.031 REF.	
h2	0.500 REF.		0.020 REF.	
L	28.000	28.400	1.102	1.118
L1	1.700	1.900	0.067	0.075
L2	0.900	1.100	0.035	0.043