

HER501 THRU HER508

HIGH EFFICIENCY RECTIFIER



康比電子
HORNBY ELECTRONIC

REVERSE VOLTAGE: 50 to 1000 VOLTS
FORWARD CURRENT: 5.0 AMPERE

FEATURES

- Plastic package has Underwriters Laboratory Flammability Classification 94V-O utilizing Flame Retardant Epoxy Molding Compound.
- Void-free Plastic in a DO-201AD package.
- 5.0 ampere operation at $T_A=50^\circ\text{C}$ With no thermal runaway.
- Ultra Fast switching for high efficiency.
- Exceeds environmental standards of MIL-S-19500/228

MECHANICAL DATA

Case: Molded plastic, DO-201AD
Terminals: Axial leads, solderable per MIL-STD-202, method 208 guaranteed
Polarity: Band denotes cathode
Mounting position: Any
Weight: 0.04ounce, 1.1gram

DO-201AD

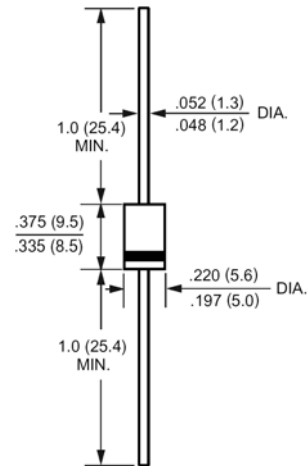

Dimensions in inches and (millimeters)

Maximum Ratings and Electrical Characteristics

Ratings at 25°C ambient temperature unless otherwise specified.
Single phase, half wave, 60Hz, resistive or inductive load.
For capacitive load, derate current by 20%.

	Symbols	HER501	HER502	HER503	HER504	HER505	HER506	HER507	HER508	Units	
Maximum Recurrent Peak Reverse Voltage	V_{RRM}	50	100	200	300	400	600	800	1000	Volts	
Maximum RMS Voltage	V_{RMS}	35	70	140	210	280	420	560	700	Volts	
Maximum DC Blocking Voltage	V_{DC}	50	100	200	300	400	600	800	1000	Volts	
Maximum Average Forward Rectified Current .375"(9.5mm) Lead Length at $T_A=50^\circ\text{C}$	$I_{(AV)}$	5.0								Amp	
Peak Forward Surge Current, 8.3ms single half-sine-wave superimposed on rated load (JEDEC method)	I_{FSM}	200				150				Amp	
Maximum Forward Voltage at 5.0A and $T_A=25^\circ\text{C}$	V_F	1.0			1.3		1.7			Volts	
Maximum Reverse Current at $T_J=25^\circ\text{C}$ at Rated DC Blocking Voltage $T_J=100^\circ\text{C}$	I_R	10.0					100				uAmp
Typical Junction Capacitance (Note 1)	C_J	70				50				pF	
Maximum Reverse Recovery Time (Note 2)	T_{RR}	50				75				nS	
Typical Thermal Resistance (Note 3)	$R_{\theta JA}$	20								$^\circ\text{C}/\text{W}$	
Operating and Storage Temperature Range	T_J, T_{stg}	-55 to +150								$^\circ\text{C}$	

NOTES:

- 1- Measured at 1 MHz and applied reverse voltage of 4.0 VDC.
- 2- Reverse Recovery Test Conditions: $I_F=5\text{A}$, $I_R=1\text{A}$, $I_{RR}=0.25\text{A}$.
- 3- Thermal Resistance from Junction to Ambient at 0.375"(9.5mm) lead length P.C.B. Mounted.

HER501 THRU HER508

HIGH EFFICIENCY RECTIFIER

RATINGS AND CHARACTERISTIC CURVES

FIG. 1 - TEST CIRCUIT DIAGRAM AND REVERSE RECOVERY TIME CHARACTERISTIC

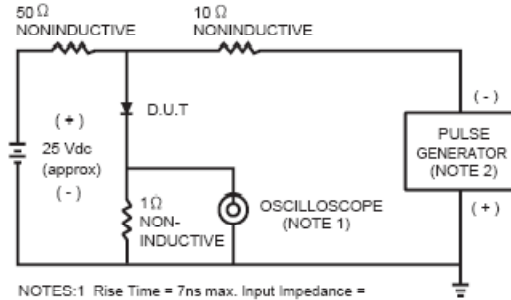

NOTES: 1 Rise Time = 7ns max. Input Impedance = 1 megohm, 22pF.
2 Rise Time = 10ns max. Source Impedance = 50 ohms.

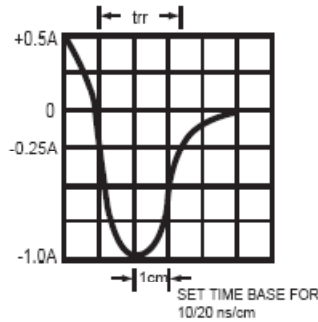

FIG. 2 - TYPICAL FORWARD CURRENT DERATING CURVE

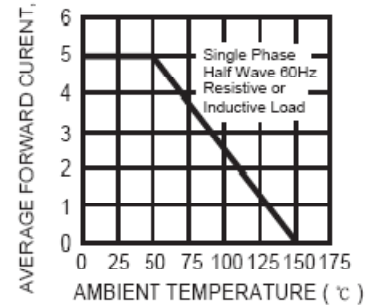

FIG. 3 - TYPICAL REVERSE CHARACTERISTICS

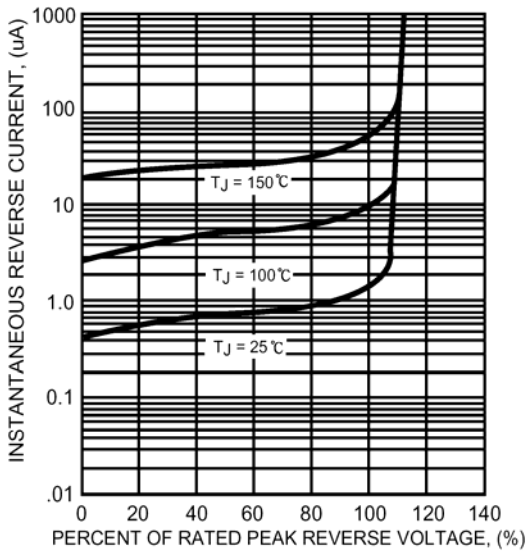

FIG. 4 - TYPICAL INSTANTANEOUS FORWARD CHARACTERISTICS

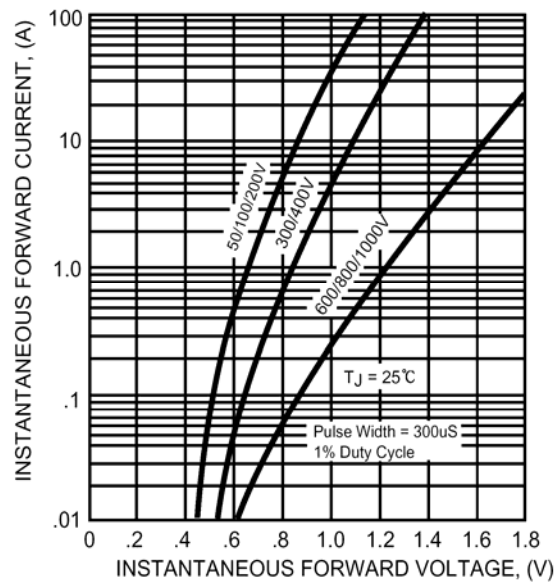

FIG. 5 - MAXIMUM NON-REPETITIVE FORWARD SURGE CURRENT

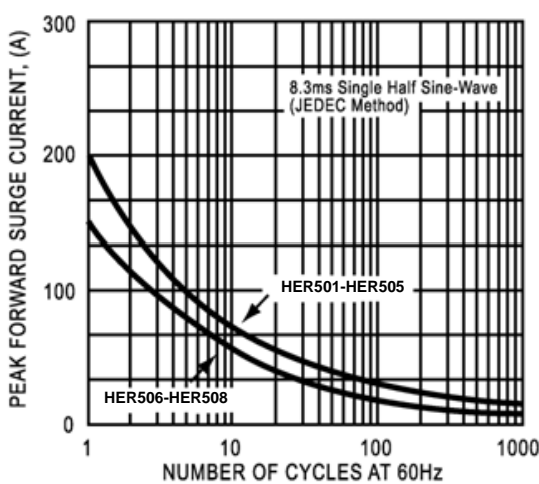

FIG. 6 - TYPICAL JUNCTION CAPACITANCE

