

SOT-23 Plastic-Encapsulate Transistors

FMMT593 TRANSISTOR (PNP)

FEATURES

- Complementary Type FMMT493

MARKING:593

MAXIMUM RATINGS (T_a=25°C unless otherwise noted)

Symbol	Parameter	Value	Unit
V _{CB0}	Collector-Base Voltage	-120	V
V _{CE0}	Collector-Emitter Voltage	-100	V
V _{EBO}	Emitter-Base Voltage	-5	V
I _C	Collector Current	-1	A
P _C	Collector Power Dissipation	250	mW
R _{θJA}	Thermal Resistance From Junction To Ambient	500	°C/W
T _j	Junction Temperature	150	°C
T _{stg}	Storage Temperature	-55~+150	°C

SOT - 23

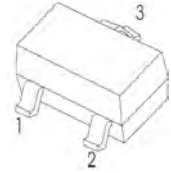

1. BASE
2. EMITTER
3. COLLECTOR

ELECTRICAL CHARACTERISTICS (T_a=25°C unless otherwise specified)

Parameter	Symbol	Test conditions	Min	Typ	Max	Unit
Collector-base breakdown voltage	V _{(BR)CBO}	I _C =-100μA, I _E =0	-120			V
Collector-emitter breakdown voltage	V _{(BR)CEO}	I _C =-10mA, I _B =0	-100			V
Emitter-base breakdown voltage	V _{(BR)EBO}	I _E =-100μA, I _C =0	-5			V
Collector cut-off current	I _{CBO}	V _{CB} =-100V, I _E =0			-0.1	μA
Collector cut-off current	I _{CES}	V _{CE} =-100V, I _E =0			-0.1	μA
Emitter cut-off current	I _{EBO}	V _{EB} =-4V, I _C =0			-0.1	μA
DC current gain	h _{FE(1)} *	V _{CE} =-5V, I _C =-1mA	100			
	h _{FE(2)} *	V _{CE} =-5V, I _C =-250mA	100			
	h _{FE(3)} *	V _{CE} =-5V, I _C =-0.5A	100		300	
	h _{FE(4)} *	V _{CE} =-5V, I _C =-1A	50			
Collector-emitter saturation voltage	V _{CE(sat)1} *	I _C =-250mA, I _B =-25mA			-0.2	V
	V _{CE(sat)2} *	I _C =-500mA, I _B =-50mA			-0.3	V
Base-emitter saturation voltage	V _{BE(sat)} *	I _C =-500mA, I _B =-50mA			-1.1	V
Base-emitter voltage	V _{BE} *	V _{CE} =-5V, I _C =-1mA			-1	V
Transition frequency	f _T	V _{CE} =-10V, I _C =-50mA, f=100MHz	50			MHz
Collector output capacitance	C _{ob}	V _{CB} =-10V, I _E =0, f=1MHz		5		pF

*Pulse test: pulse width ≤300μs, duty cycles ≤ 2.0%.

Typical Characteristics

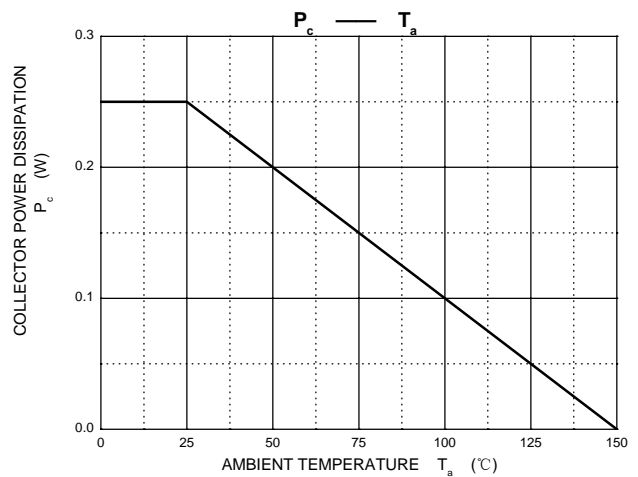
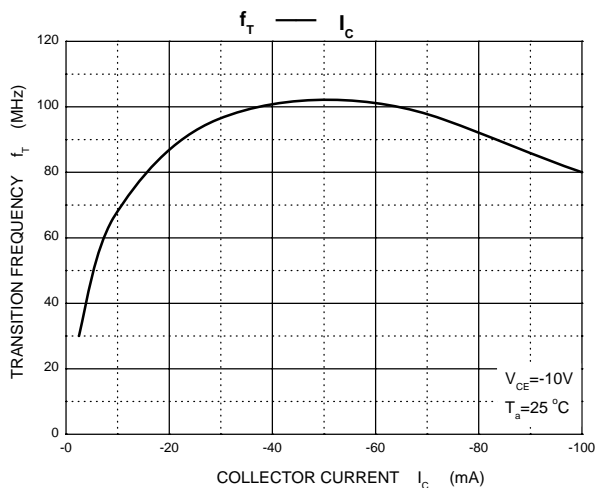
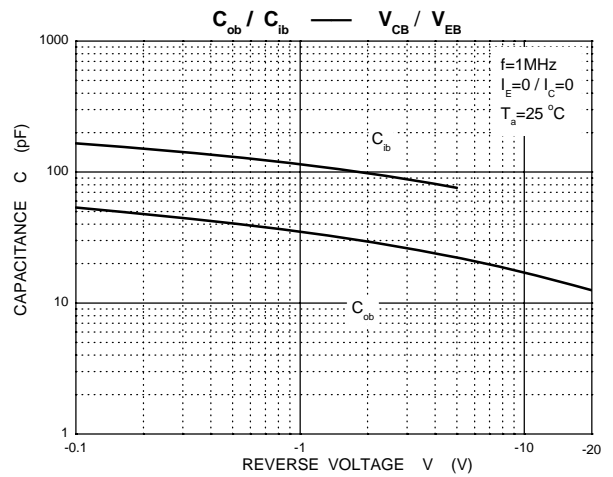
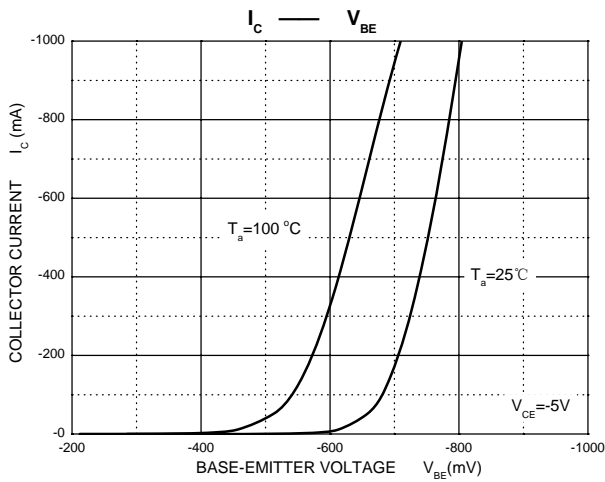
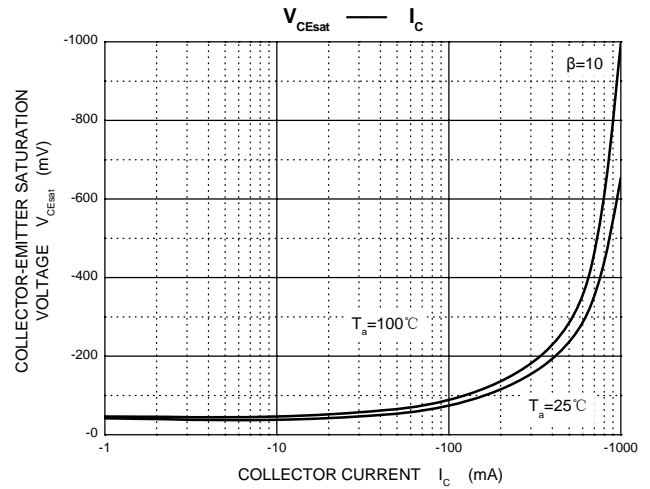
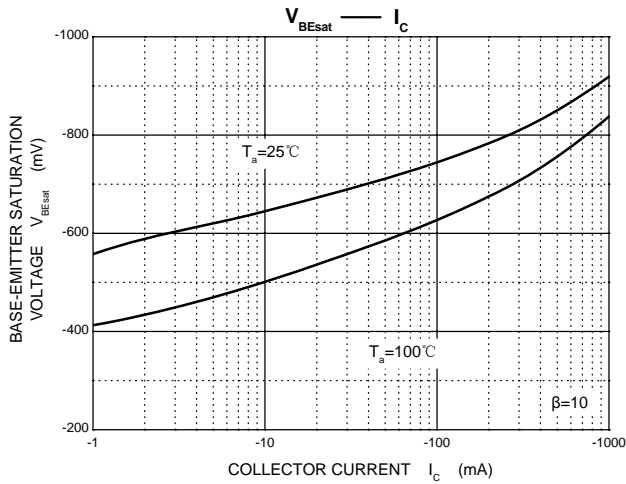
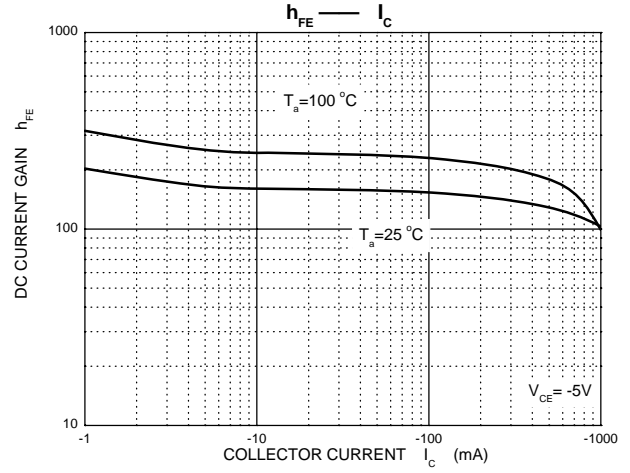
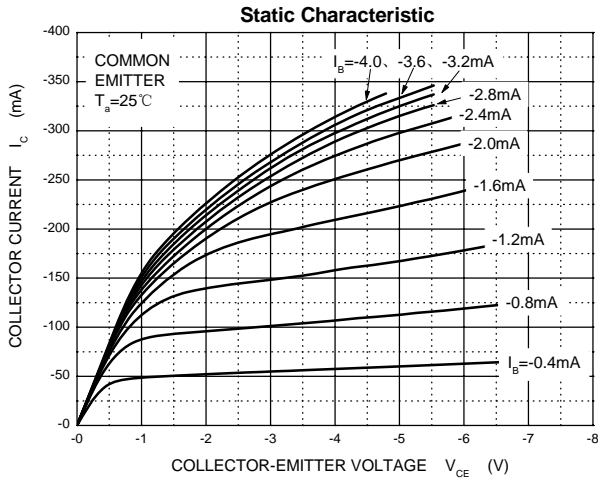

SOT-23 Package Outline Dimensions



Symbol	Dimensions In Millimeters		Dimensions In Inches	
	Min	Max	Min	Max
A	0.900	1.150	0.035	0.045
A1	0.000	0.100	0.000	0.004
A2	0.900	1.050	0.035	0.041
b	0.300	0.500	0.012	0.020
c	0.080	0.150	0.003	0.006
D	2.800	3.000	0.110	0.118
E	1.200	1.400	0.047	0.055
E1	2.250	2.550	0.089	0.100
e	0.950 TYP		0.037 TYP	
e1	1.800	2.000	0.071	0.079
L	0.550 REF		0.022 REF	
L1	0.300	0.500	0.012	0.020
θ	0°	8°	0°	8°

SOT-23 Suggested Pad Layout



Note:

1. Controlling dimension: in millimeters.
2. General tolerance: $\pm 0.05\text{mm}$.
3. The pad layout is for reference purposes only.

NOTICE

JCET reserve the right to make modifications, enhancements, improvements, corrections or other changes without further notice to any product herein. JCET does not assume any liability arising out of the application or use of any product described herein.

SOT-23 Tape and Reel

SOT-23 Embossed Carrier Tape

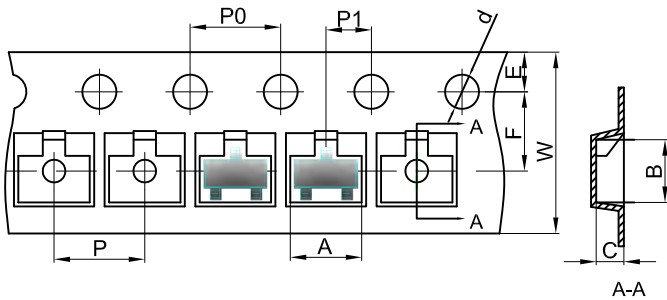

Packaging Description:

SOT-23 parts are shipped in tape. The carrier tape is made from a dissipative (carbon filled) polycarbonate resin. The cover tape is a multilayer film (Heat Activated Adhesive in nature) primarily composed of polyester film, adhesive layer, sealant, and anti-static sprayed agent. These reeled parts in standard option are shipped with 3,000 units per 7" or 17.8cm diameter reel. The reels are clear in color and is made of polystyrene plastic (anti-static coated).

Dimensions are in millimeter

Pkg type	A	B	C	d	E	F	P0	P	P1	W
SOT-23	3.15	2.77	1.22	Ø1.50	1.75	3.50	4.00	4.00	2.00	8.00

SOT-23 Tape Leader and Trailer

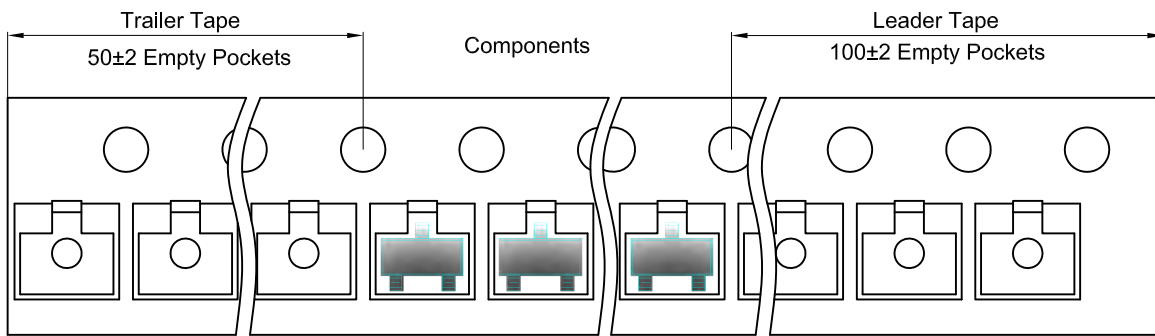

SOT-23 Reel



Dimensions are in millimeter

Reel Option	D	D1	D2	G	H	I	W1	W2
7"Dia	Ø178.00	54.40	13.00	R78.00	R25.60	R6.50	9.50	12.30

REEL	Reel Size	Box	Box Size(mm)	Carton	Carton Size(mm)	G.W.(kg)
3000 pcs	7 inch	45,000 pcs	203×203×195	180,000 pcs	438×438×220	