



SOT-223 Plastic-Encapsulate Transistors

CZT31C TRANSISTOR (NPN)

FEATURES

- Complementary to CZT32C
- Power amplifier applications up to 3.0 amps.

MARKING:

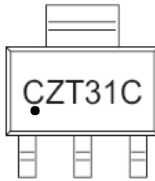

Solid dot = Green molding compound device,
if none, the normal device.

SOT-223

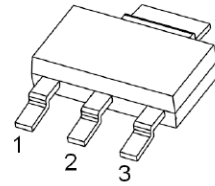

1. BASE
2. COLLECTOR
3. EMITTER

MAXIMUM RATINGS (T_a=25°C unless otherwise noted)

Symbol	Parameter	Value	Unit
V _{CB0}	Collector-Base Voltage	100	V
V _{CEO}	Collector-Emitter Voltage	100	V
V _{EBO}	Emitter-Base Voltage	5	V
I _C	Collector Current -Continuous	3	A
P _C	Collector Power Dissipation	1	W
T _j	Junction Temperature	150	°C
T _{stg}	Storage Temperature	-65~150	°C

ELECTRICAL CHARACTERISTICS(T_a=25°C unless otherwise specified)

Parameter	Symbol	Test conditions	Min	Typ	Max	Unit
Collector-base breakdown voltage	V _{(BR)CBO}	I _C =1mA, I _E =0	100			V
Collector-emitter breakdown voltage	V _{(BR)CEO}	I _C =30mA, I _B =0	100			V
Emitter-base breakdown voltage	V _{(BR)EBO}	I _E =3mA, I _C =0	5			V
Collector cut-off current	I _{CBO}	V _{CB} =100V, I _E =0			200	uA
Base cut-off current	I _{CEO}	V _{CE} =60V, I _B =0			300	uA
Emitter cut-off current	I _{EBO}	V _{EB} =5V, I _C =0			1	mA
DC current gain	h _{FE(1)} *	V _{CE} =4V, I _C =1A	25			
	h _{FE(2)} *	V _{CE} =4V, I _C =3A	10		100	
Collector-emitter saturation voltage	V _{CE(sat)} *	I _C =3.0A, I _B =375mA			1.2	V
Base-emitter voltage	V _{BE} *	V _{CE} =4V, I _C =3A			1.8	V
Transition frequency	f _T	V _{CE} =10V, I _C =500mA, f=1MHz	3			MHz

* Pulsed , 2%D.C.

Typical Characteristics

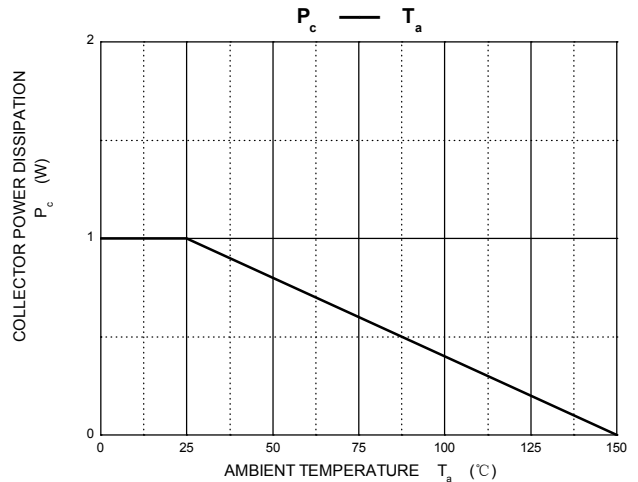
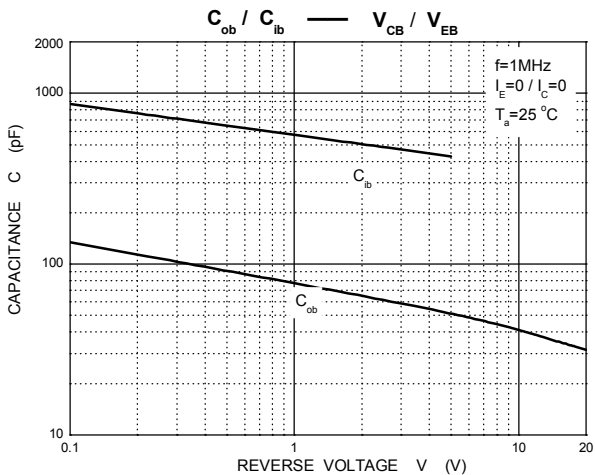
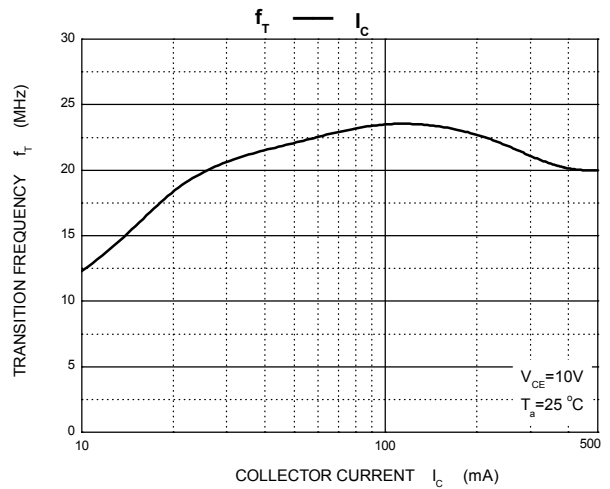
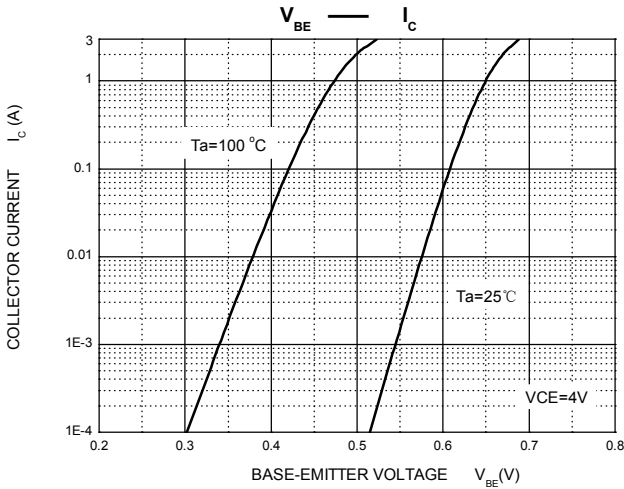
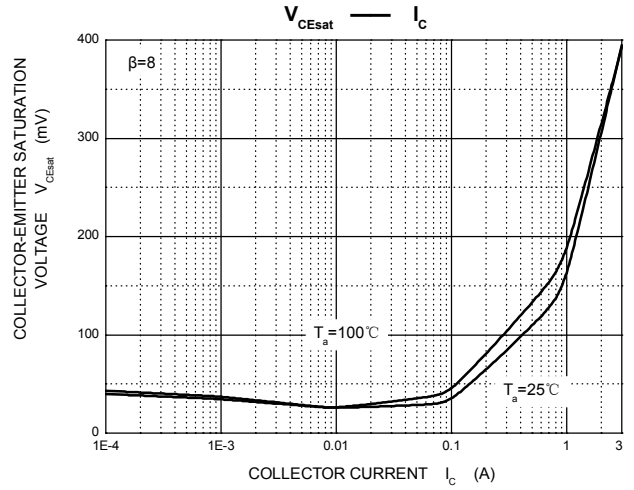
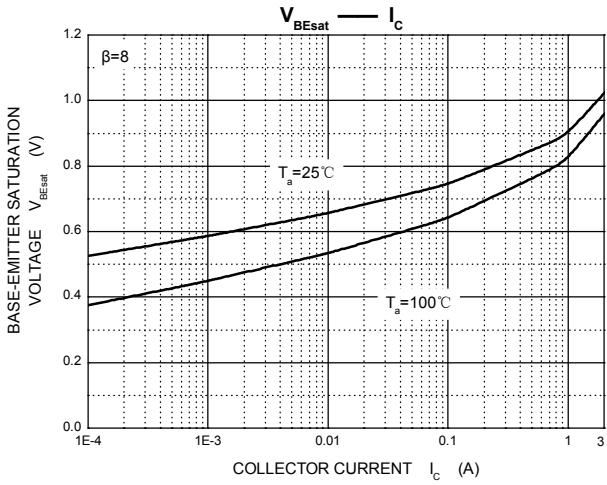
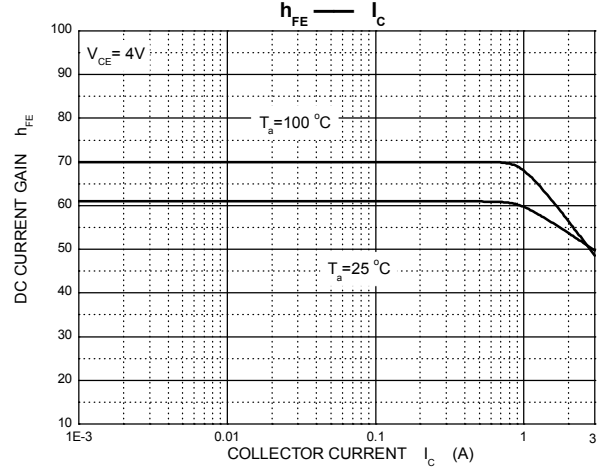
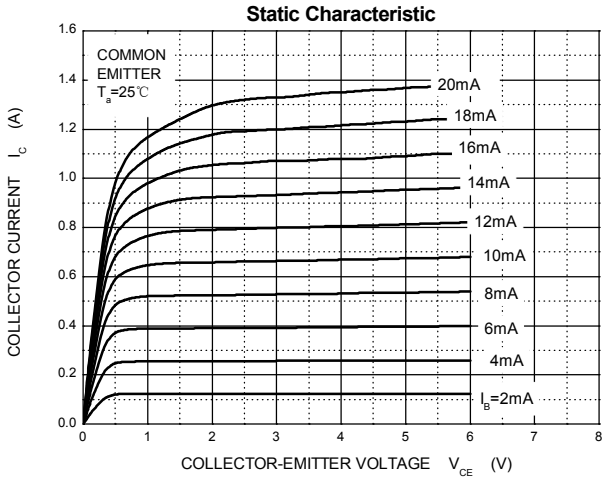

SOT-223 Package Outline Dimensions

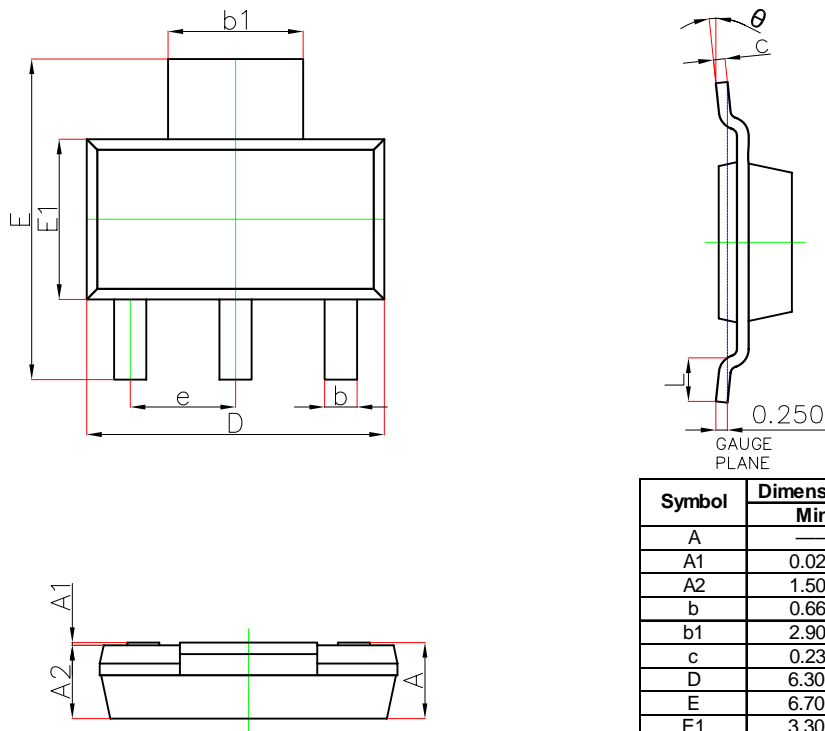

Symbol	Dimensions In Millimeters		Dimensions In Inches	
	Min.	Max.	Min.	Max.
A	—	1.800	—	0.071
A1	0.020	0.100	0.001	0.004
A2	1.500	1.700	0.059	0.067
b	0.660	0.840	0.026	0.033
b_1	2.900	3.100	0.114	0.122
c	0.230	0.350	0.009	0.014
D	6.300	6.700	0.248	0.264
E	6.700	7.300	0.264	0.287
E_1	3.300	3.700	0.130	0.146
e	2.300(BSC)		0.091(BSC)	
L	0.750	—	0.030	—
θ	0°	10°	0°	10°

SOT-223 Suggested Pad Layout

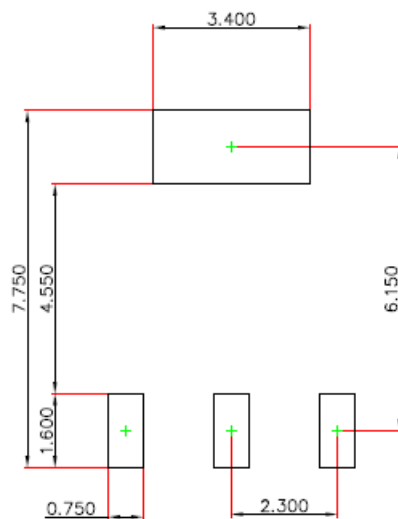

Note:

1. Controlling dimension: in millimeters.
2. General tolerance: ± 0.050 mm.
3. The pad layout is for reference purposes only.

NOTICE

JCET reserve the right to make modifications, enhancements, improvements, corrections or other changes without further notice to any product herein. JCET does not assume any liability arising out of the application or use of any product described herein.

SOT-223 Tape and Reel

SOT-223 Embossed Carrier Tape



Packaging Description:
 SOT-223 parts are shipped in tape. The carrier tape is made from a dissipative (carbon filled) polycarbonate resin. The cover tape is a multilayer film (Heat Activated Adhesive in nature) primarily composed of polyester film, adhesive layer, sealant, and anti-static sprayed agent. These reeled parts in standard option are shipped with 2,500 units per 13" or 33.0cm diameter reel. The reels are clear in color and is made of polystyrene plastic (anti-static coated).

Dimensions are in millimeter										
Pkg type	A	B	C	d	E	F	P0	P	P1	W
SOT-223	6.765	7.335	1.88	Ø1.50	1.75	5.50	4.00	8.00	2.00	12.00

SOT-223 Tape Leader and Trailer

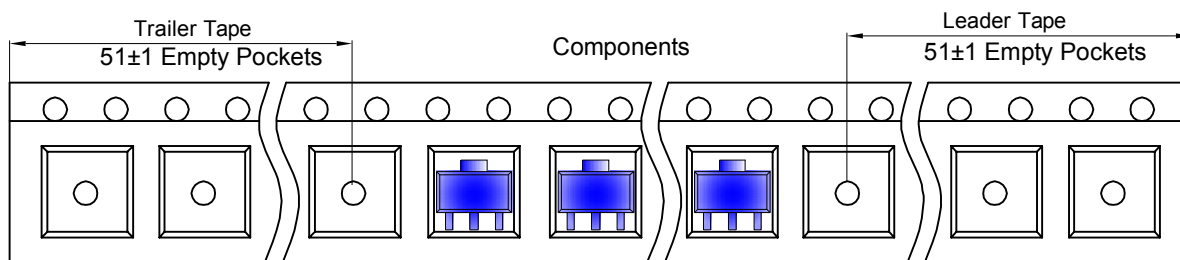

SOT-223 Reel

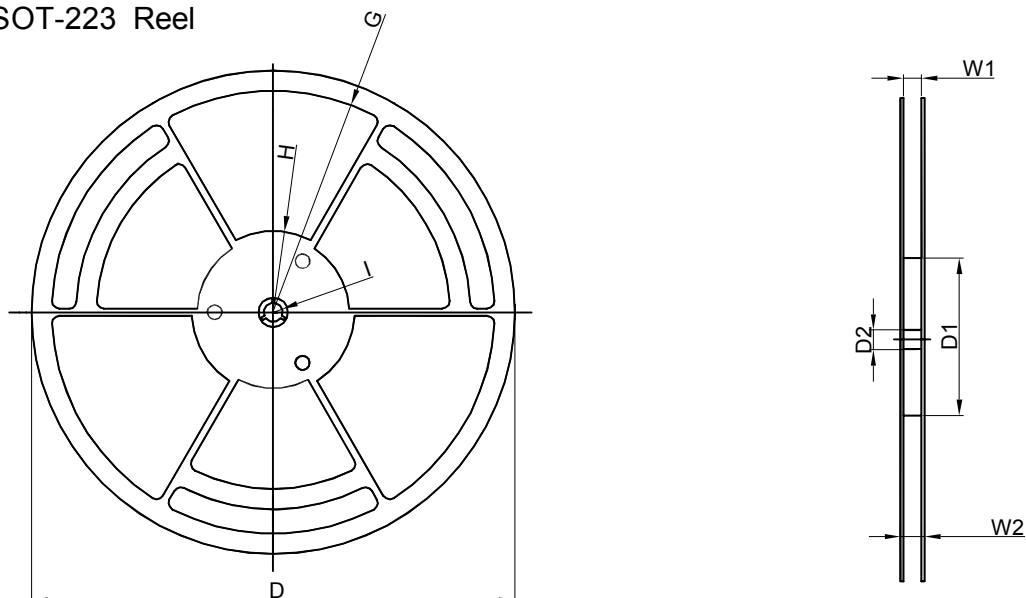

Dimensions are in millimeter								
Reel Option	D	D1	D2	G	H	I	W1	W2
13" Dia	Ø330.00	100.00	13.00	R151.00	R56.00	R6.50	12.40	17.60

REEL	Reel Size	Box	Box Size(mm)	Carton	Carton Size(mm)	G.W.(kg)
2,500 pcs	13 inch	2,500 pcs	336×336×48	20,000 pcs	445×355×365	