

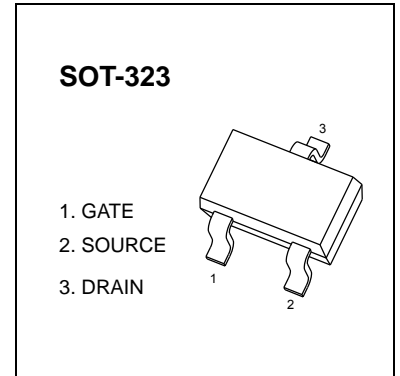

## SOT-323 Plastic-Encapsulate MOSFETS

### CJW1012 N-Channel Power MOSFET

$V_{(BR)DSS}$	$R_{DS(on)MAX}$	$I_D$
20V	700mΩ@4.5V	500mA
	850mΩ@2.5V	



#### GENERAL DESCRIPTION

This Single N-Channel MOSFET has been designed using advanced Power Trench process to optimize the  $R_{DS(ON)}$ .

#### FEATURE

- High-Side Switching
- Low On-Resistance
- Low Threshold
- Fast Switching Speed
- ESD protected

#### APPLICATION

- Drivers: Relays, Solenoids, Lamps, Hammers, Displays, Memories
- Battery Operated Systems
- Power Supply Converter Circuits
- Load/Power Switching Cell Phones, Pagers

#### MARKING

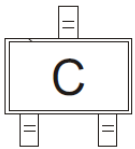

#### Equivalent Circuit

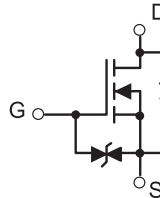

#### Maximum ratings ( $T_a=25^\circ\text{C}$ unless otherwise noted)

Parameter	Symbol	Value	Unit
Drain-Source voltage	$V_{DSS}$	20	V
Gate-Source Voltage	$V_{GS}$	±12	
Drain Current-Continuous	$I_{D(DC)}$	500	mA
Drain Current -Pulsed(note1)	$I_{DM(pulse)}$	1000	
Power Dissipation (note 2 , $T_a=25^\circ\text{C}$ )	$P_D$	150	mW
Maximum Power Dissipation (note 3 , $T_c=25^\circ\text{C}$ )		275	
Thermal Resistance from Junction to Ambient	$R_{\theta JA}$	833	$^\circ\text{C/W}$
Thermal Resistance from Junction to Case	$R_{\theta JC}$	455	
Storage Temperature	$T_j$	150	$^\circ\text{C}$
Junction Temperature	$T_{stg}$	-55 ~+150	

## MOSFET ELECTRICAL CHARACTERISTICS

$T_a=25^\circ\text{C}$  unless otherwise specified

Parameter	Symbol	Test Condition	Min	Typ	Max	Unit
<b>On/Off States</b>						
Drain-Source Breakdown Voltage	$V_{(BR)DSS}$	$V_{GS} = 0V, I_D = 250\mu A$	20			V
Gate-Threshold Voltage	$V_{GS(th)}$	$V_{DS} = V_{GS}, I_D = 250\mu A$	0.45		1.2	
Gate-Body Leakage Current	$I_{GSS}$	$V_{DS} = 0V, V_{GS} = \pm 4.5V$			$\pm 1$	$\mu A$
Zero Gate Voltage Drain Current	$I_{DSS}$	$V_{DS} = 16V, V_{GS} = 0V$			100	nA
Drain-Source On-State Resistance	$R_{DS(on)}$	$V_{GS} = 4.5V, I_D = 600mA$			700	m $\Omega$
		$V_{GS} = 2.5V, I_D = 500mA$			850	
Forward Transconductance	$g_{FS}$	$V_{DS} = 10V, I_D = 400mA$		1		S
<b>Dynamic Characteristics</b>						
Input Capacitance (note 4)	$C_{iss}$	$V_{DS} = 16V, V_{GS} = 0V, f = 1MHz$		100		pF
Output Capacitance (note 4)	$C_{oss}$			16		
Reverse Transfer Capacitance (note 4)	$C_{rss}$			12		
Total Gate Charge	$Q_g$	$V_{DS} = 10V, V_{GS} = 4.5V, I_D = 250mA$		750		nC
Gate-Source Charge	$Q_{gs}$			75		
Gate-Drain Charge	$Q_{gd}$			225		
<b>Switching Times (note 4)</b>						
Turn-On Delay Time	$t_{d(on)}$	$V_{DD} = 10V, R_L = 47\Omega, I_D = 200mA, V_{GS} = 4.5V, R_G = 10\Omega$		5		nS
Rise Time	$t_r$			5		
Turn-Off Delay Time	$t_{d(off)}$			25		
Fall Time	$t_f$			11		
<b>Drain-Source Diode Characteristics</b>						
Drain-Source Diode Forward Voltage (note 5)	$V_{SD}$	$I_S = 0.15A, V_{GS} = 0V$			1.2	V

### Notes:

1. Repetitive Rating: Pulse width limited by maximum junction temperature.
2. This test is performed with no heat sink at  $T_a=25^\circ\text{C}$ .
3. This test is performed with infinite heat sink at  $T_c=25^\circ\text{C}$ .
4. These parameters have no way to verify.
5. Pulse Test : Pulse Width  $\leq 300\mu s$ , Duty Cycle  $\leq 0.5\%$ .

# Typical Characteristics

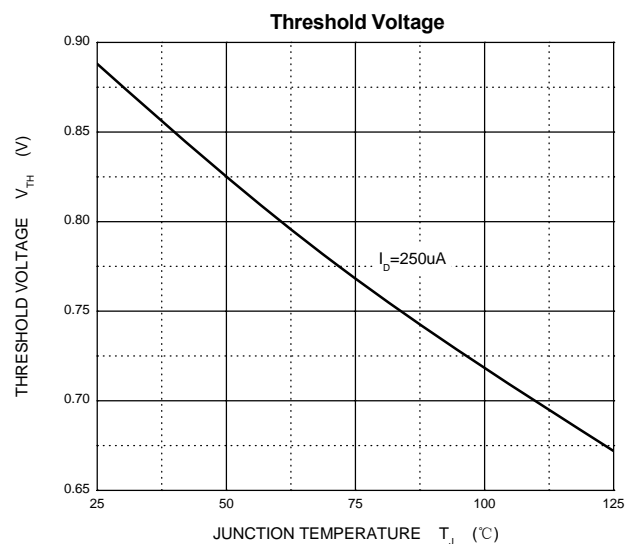
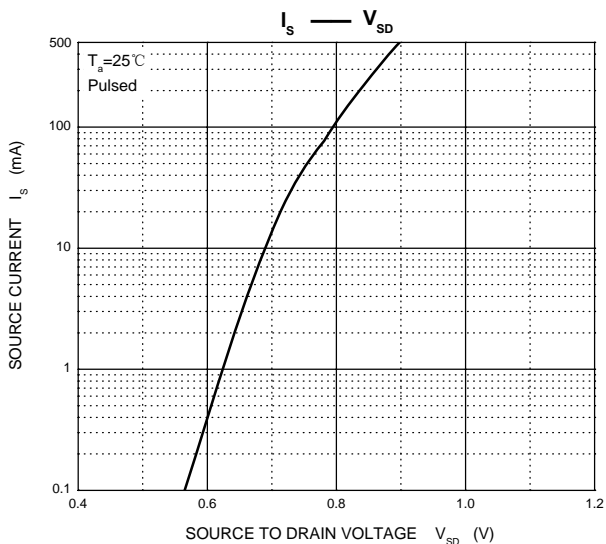
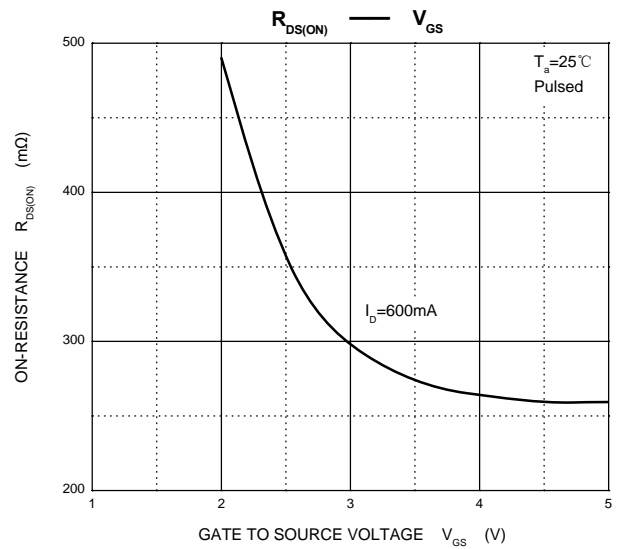
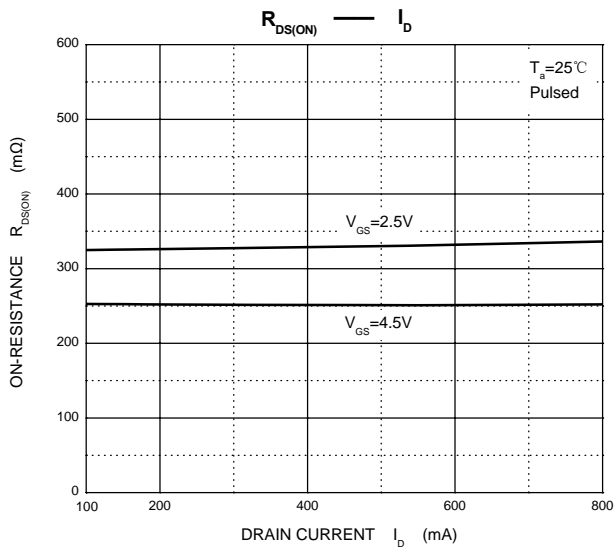
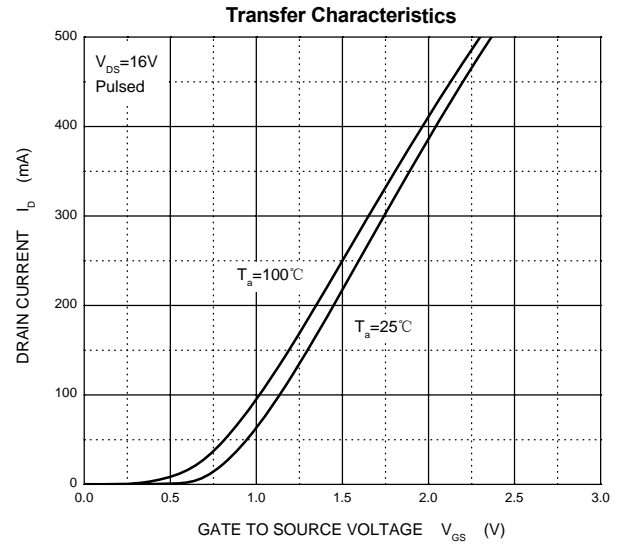
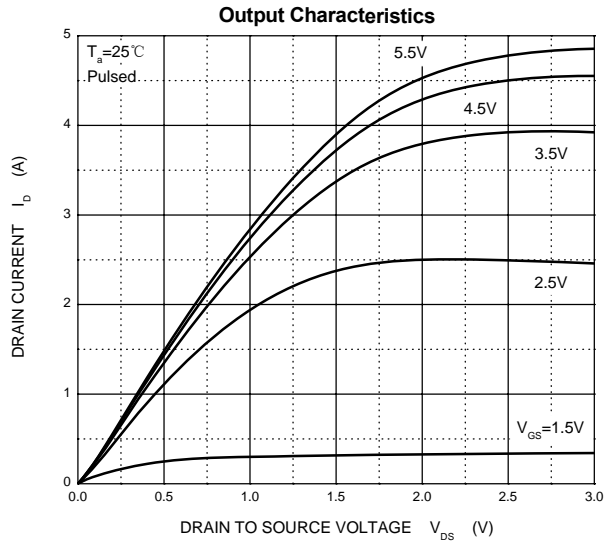

## SOT-323 Package Outline Dimensions

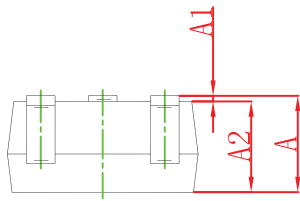
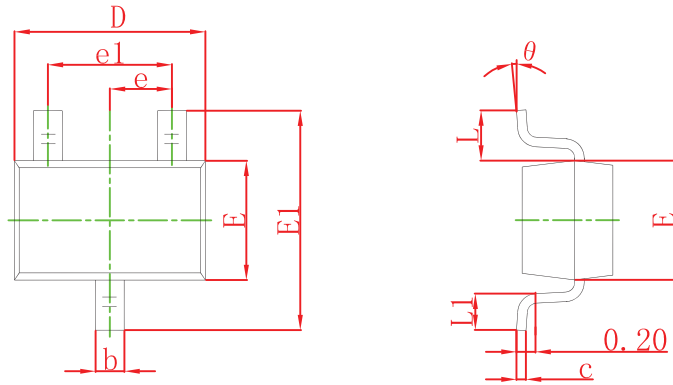

Symbol	Dimensions In Millimeters		Dimensions In Inches	
	Min	Max	Min	Max
A	0.900	1.100	0.035	0.043
A1	0.000	0.100	0.000	0.004
A2	0.900	1.000	0.035	0.039
b	0.200	0.400	0.008	0.016
c	0.080	0.150	0.003	0.006
D	2.000	2.200	0.079	0.087
E	1.150	1.350	0.045	0.053
E1	2.150	2.450	0.085	0.096
e	0.650 TYP		0.026 TYP	
e1	1.200	1.400	0.047	0.055
L	0.525 REF		0.021 REF	
L1	0.260	0.460	0.010	0.018
theta	0°	8°	0°	8°

## SOT-323 Suggested Pad Layout

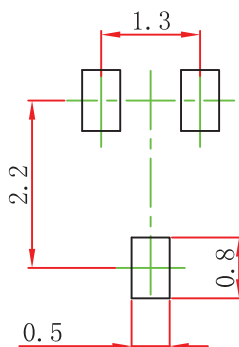

- Note:
1. Controlling dimension: in millimeters.
  2. General tolerance:  $\pm 0.05$  mm.
  3. The pad layout is for reference purposes only.

### NOTICE

JCET reserve the right to make modifications, enhancements, improvements, corrections or other changes without further notice to any product herein. JCET does not assume any liability arising out of the application or use of any product described herein.

# SOT-323 Tape and reel

## SOT-323 Embossed Carrier Tape

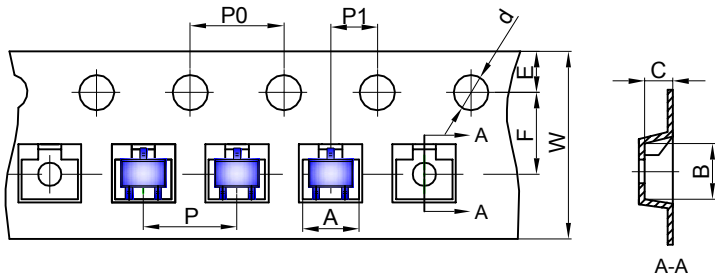

**Packaging Description:**  
 SOT-323 parts are shipped in tape. The carrier tape is made from a dissipative (carbon filled) polycarbonate resin. The cover tape is a multilayer film (Heat Activated Adhesive in nature) primarily composed of polyester film, adhesive layer, sealant, and anti-static sprayed agent. These reeled parts in standard option are shipped with 3,000 units per 7" or 17.8cm diameter reel. The reels are clear in color and is made of polystyrene plastic (anti-static coated).

Dimensions are in millimeter										
Pkg type	A	B	C	d	E	F	P0	P	P1	W
SOT-323	2.25	2.55	1.19	Ø1.55	1.75	3.50	4.00	4.00	2.00	8.00

## SOT-323 Tape Leader and Trailer

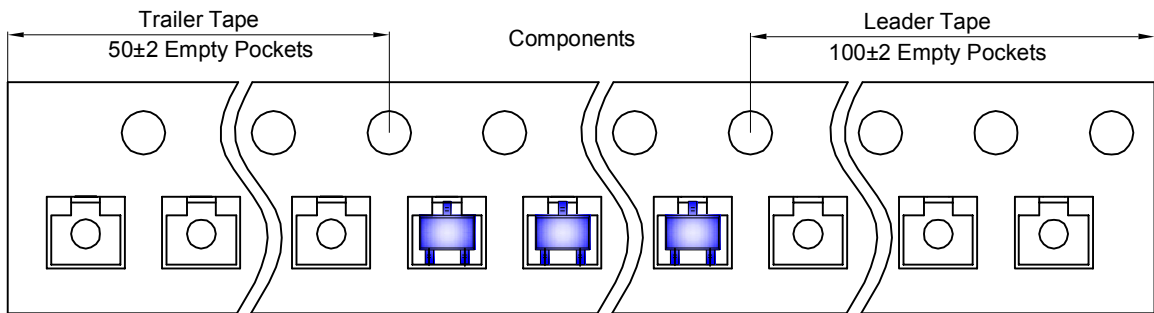

## SOT-323 Reel

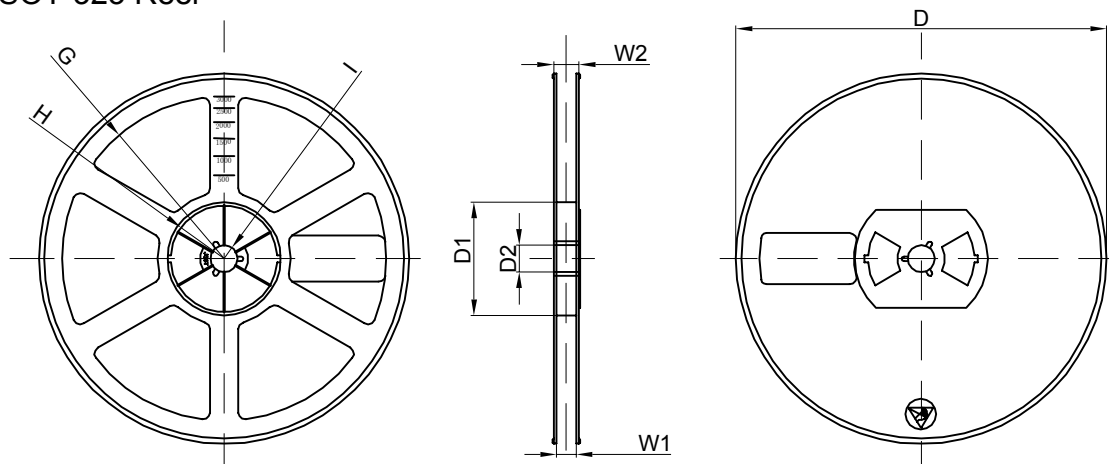

Dimensions are in millimeter								
Reel Option	D	D1	D2	G	H	I	W1	W2
7" Dia	Ø178.00	54.40	13.00	R78.00	R25.60	R6.50	9.50	12.30

REEL	Reel Size	Box	Box Size(mm)	Carton	Carton Size(mm)	G.W.(kg)
3000 pcs	7 inch	30,000 pcs	203×203×195	120,000 pcs	438×438×220	