

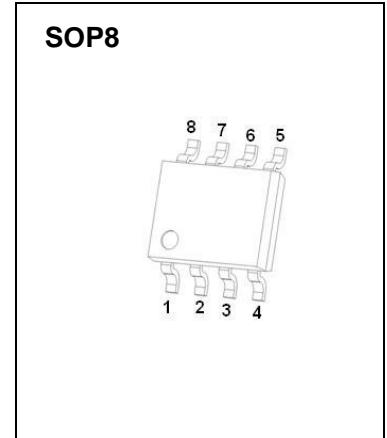

## SOP8 Plastic-Encapsulate MOSFETS

### CJQ4438 N-Channel MOSFET

| $V_{(BR)DSS}$ | $R_{DS(on)MAX}$ | $I_D$ |
|---------------|-----------------|-------|
| 60V           | 22mΩ@10V        | 8.2A  |
|               | 36mΩ@4.5V       |       |



#### FEATURE

- TrenchFET Power MOSFET
- Low  $R_{DS(on)}$
- Low Gate Charge

#### APPLICATION

- Load Switch
- PWM applications

#### MARKING

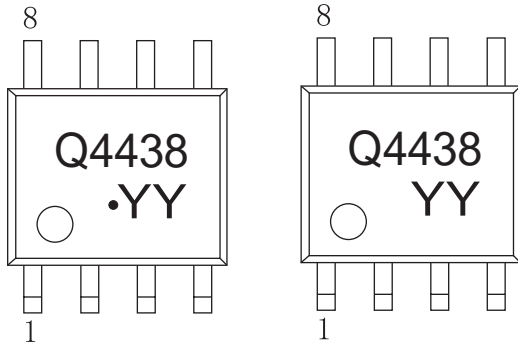

Front side

Q4438 = Device code

Solid dot=Pin1 indicator

Solid dot = Green molding compound device,  
if none, the normal device

YY=Date Code

#### Equivalent Circuit

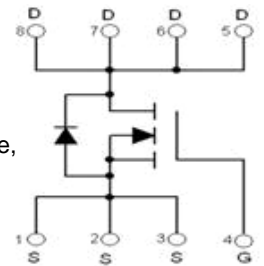

#### Maximum ratings ( $T_a=25^\circ\text{C}$ unless otherwise noted)

| Parameter  | Symbol          | Value    | Unit               |
|--|-----------------|----------|--------------------|
| Drain-Source Voltage                                 | $V_{DS}$        | 60       | V                  |
| Gate-Source Voltage                                  | $V_{GS}$        | $\pm 20$ | V                  |
| Continuous Drain Current (note 1)                    | $I_D$           | 8.2      | A                  |
| Pulsed Drain Current (note 2)                        | $I_{DM}$        | 40       | A                  |
| Power Dissipation                                    | $P_D$           | 1.25     | W                  |
| Thermal Resistance from Junction to Ambient (note 1) | $R_{\theta JA}$ | 100      | $^\circ\text{C/W}$ |
| Junction Temperature                                 | $T_J$           | 150      | $^\circ\text{C}$   |
| Storage Temperature                                  | $T_{STG}$       | -55~+150 | $^\circ\text{C}$   |

## MOSFET ELECTRICAL CHARACTERISTICS

T<sub>a</sub> =25 °C unless otherwise specified

| Parameter                            | Symbol               | Test Condition   | Min | Typ  | Max  | Unit |
|--------------------------------------|----------------------|--|-----|------|------|------|
| <b>STATIC PARAMETERS</b>             |                      |  |     |      |      |      |
| Drain-source breakdown voltage       | V <sub>(BR)DSS</sub> | V <sub>GS</sub> = 0V, I <sub>D</sub> =250μA  | 60  |      |      | V    |
| Zero gate voltage drain current      | I <sub>DSS</sub>     | V <sub>DS</sub> =60V, V <sub>GS</sub> = 0V   |     |      | 1    | μA   |
| Gate-body leakage current            | I <sub>GSS</sub>     | V <sub>GS</sub> =±20V, V <sub>DS</sub> = 0V  |     |      | ±100 | nA   |
| Gate threshold voltage               | V <sub>GS(th)</sub>  | V <sub>DS</sub> =V <sub>GS</sub> , I <sub>D</sub> =250μA                                 | 1   |      | 3    | V    |
| Drain-source on-resistance (note 3)  | R <sub>DS(on)</sub>  | V <sub>GS</sub> =10V, I <sub>D</sub> =8.2A   |     |      | 22   | mΩ   |
|                                      |                      | V <sub>GS</sub> =4.5V, I <sub>D</sub> =7.6A  |     |      | 36   | mΩ   |
| Forward tranconductance (note 3)     | g <sub>fs</sub>      | V <sub>DS</sub> =5V, I <sub>D</sub> =8.2A  | 10  |      |      | S    |
| Diode forward voltage (note 3)       | V <sub>SD</sub>      | I <sub>S</sub> =1A, V <sub>GS</sub> = 0V   |     |      | 1    | V    |
| <b>DYNAMIC PARAMETERS (note 4)</b>   |                      |  |     |      |      |      |
| Input Capacitance                    | C <sub>iss</sub>     | V <sub>DS</sub> =30V, V <sub>GS</sub> =0V, f =1MHz                                       |     |      | 2300 | pF   |
| Output Capacitance                   | C <sub>oss</sub>     |  |     | 155  |      | pF   |
| Reverse Transfer Capacitance         | C <sub>rss</sub>     |  |     | 116  |      | pF   |
| <b>SWITCHING PARAMETERS (note 4)</b> |                      |  |     |      |      |      |
| Turn-on delay time                   | t <sub>d(on)</sub>   | V <sub>GS</sub> =10V, V <sub>DS</sub> =30V<br>R <sub>L</sub> =3.6Ω, R <sub>GEN</sub> =3Ω |     | 8.2  |      | ns   |
| Turn-on rise time                    | t <sub>r</sub>       |  |     | 5.5  |      | ns   |
| Turn-off delay time                  | t <sub>d(off)</sub>  |  |     | 29.7 |      | ns   |
| Turn-off fall time                   | t <sub>f</sub>       |  |     | 5.2  |      | ns   |
| Total Gate Charge (10V)              | Q <sub>g</sub>       | V <sub>DS</sub> =30V, V <sub>GS</sub> =10V, I <sub>D</sub> =8.2A                         |     |      | 58   | nC   |
| Total Gate Charge (4.5V)             |                      |  |     |      | 30   | nC   |
| Gate-Source Charge                   | Q <sub>gs</sub>      |  |     | 6    |      | nC   |
| Gate-Drain Charge                    | Q <sub>gd</sub>      |  |     | 14.4 |      | nC   |

### Notes :

1. The value of R<sub>θJA</sub> is measured with the device mounted on 1 in<sup>2</sup> FR4 board with 2oz. Copper, in a still air environment with T<sub>a</sub>=25°C. The value in any given application depends on the user's specific board design. The current rating is based on the t ≤10s thermal resistance rating.
2. Repetitive rating : Pulse width limited by junction temperature.
3. Pulse Test : Pulse Width ≤300μs, Duty Cycle ≤2%.
4. These parameters have no way to verify.

# Typical Characteristics

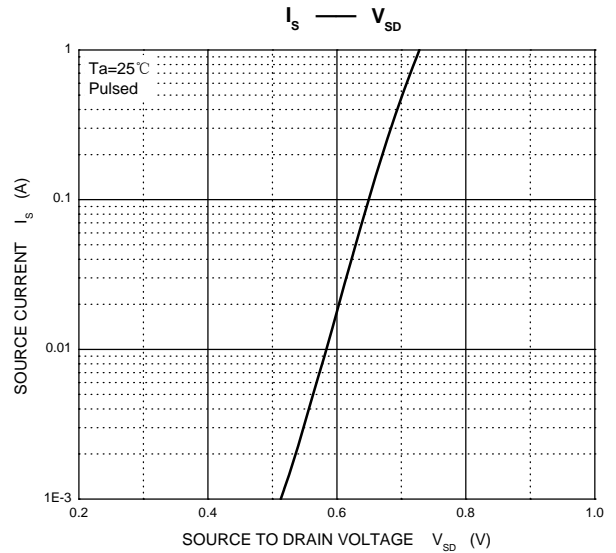
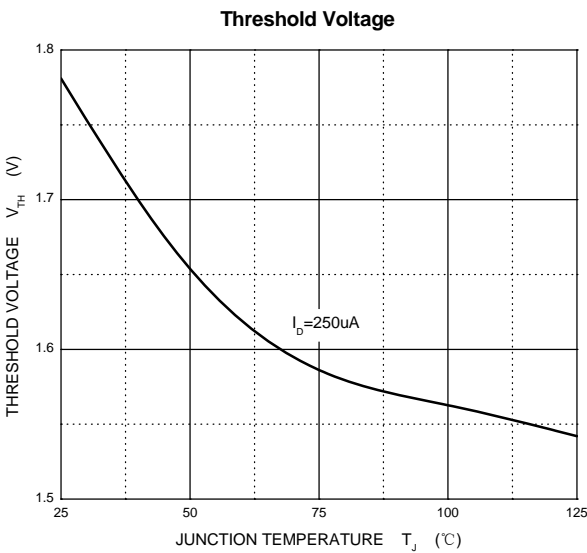
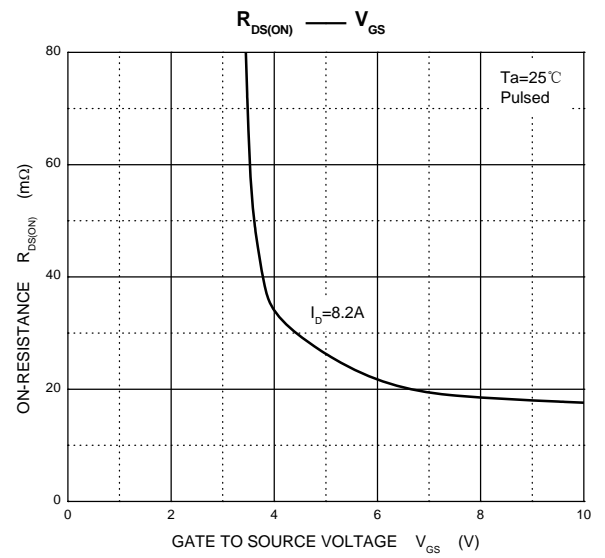
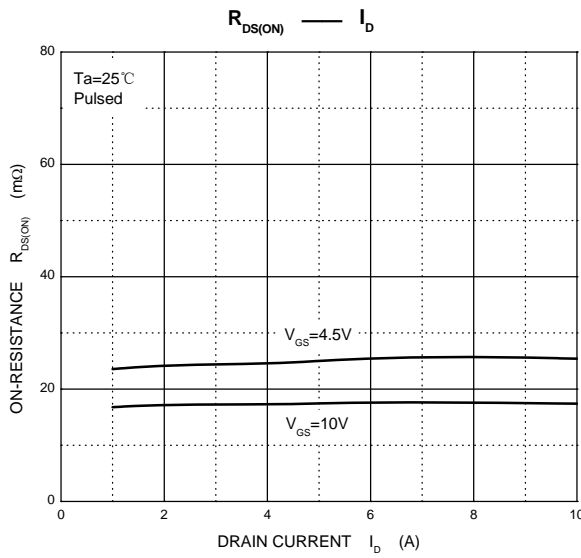
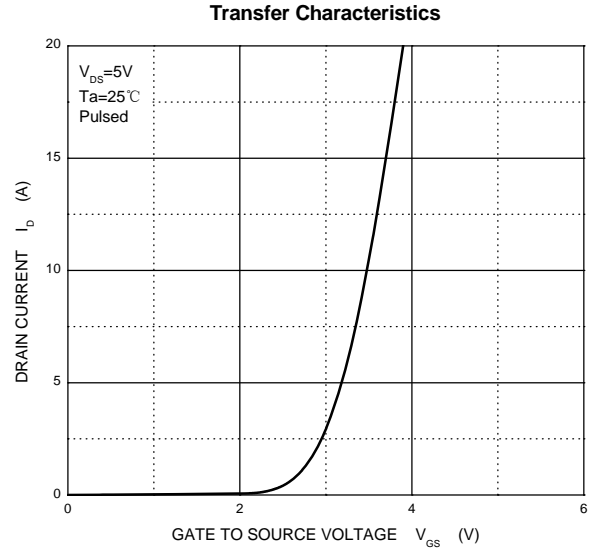
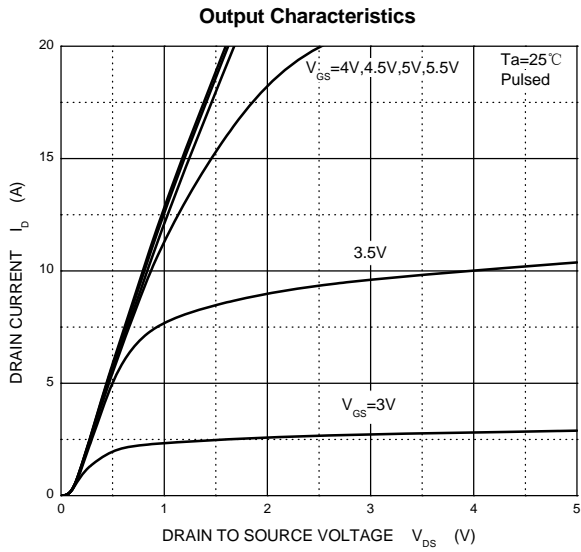

## SOP8 Package Outline Dimensions

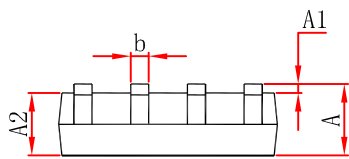
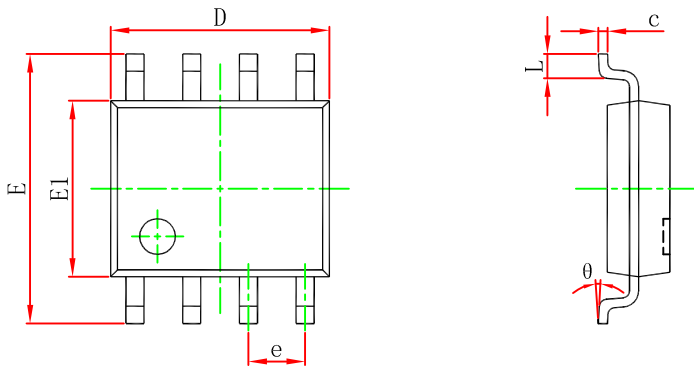

| Symbol | Dimensions In Millimeters |       | Dimensions In Inches |       |
|--------|---------------------------|-------|----------------------|-------|
|        | Min                       | Max   | Min                  | Max   |
| A      | 1.350                     | 1.750 | 0.053                | 0.069 |
| A1     | 0.100                     | 0.250 | 0.004                | 0.010 |
| A2     | 1.350                     | 1.550 | 0.053                | 0.061 |
| b      | 0.330                     | 0.510 | 0.013                | 0.020 |
| c      | 0.170                     | 0.250 | 0.007                | 0.010 |
| D      | 4.800                     | 5.000 | 0.189                | 0.197 |
| e      | 1.270 (BSC)               |       | 0.050 (BSC)          |       |
| E      | 5.800                     | 6.200 | 0.228                | 0.244 |
| E1     | 3.800                     | 4.000 | 0.150                | 0.157 |
| L      | 0.400                     | 1.270 | 0.016                | 0.050 |
| theta  | 0°                        | 8°    | 0°                   | 8°    |

## SOP8 Suggested Pad Layout

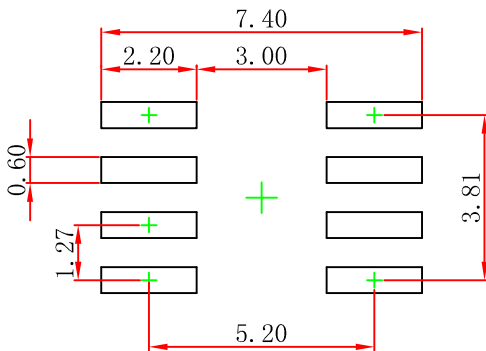

- Note:
1. Controlling dimension: in millimeters.
  2. General tolerance:  $\pm 0.05\text{mm}$ .
  3. The pad layout is for reference purposes only.

### NOTICE

JCET reserve the right to make modifications, enhancements, improvements, corrections or other changes without further notice to any product herein. JCET does not assume any liability arising out of the application or use of any product described herein.

# SOP8 Tape and Reel

## SOP8 Embossed Carrier Tape

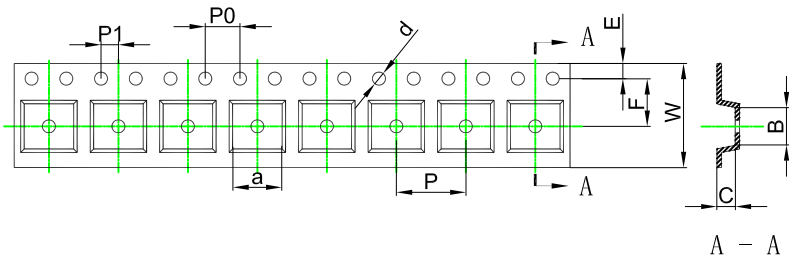

### Packaging Description:

SOP8 parts are shipped in tape. The carrier tape is made from a dissipative (carbon filled) polycarbonate resin. The cover tape is a multilayer film (Heat Activated Adhesive in nature) primarily composed of polyester film, adhesive layer, sealant, and anti-static sprayed agent. These reeled parts in standard option are shipped with 2,500 units per 13" or 33cm diameter reel. The reels are clear in color and is made of polystyrene plastic (anti-static coated).

ALL DIM IN mm

| Dimensions are in millimeter |      |      |      |       |      |      |      |      |      |       |
|------------------------------|------|------|------|-------|------|------|------|------|------|-------|
| Pkg type                     | a    | B    | C    | d     | E    | F    | P0   | P    | P1   | W     |
| SOP8                         | 6.40 | 5.40 | 2.10 | Ø1.50 | 1.75 | 5.50 | 4.00 | 8.00 | 2.00 | 12.00 |

## SOP8 Tape Leader and Trailer



## SOP8 Reel

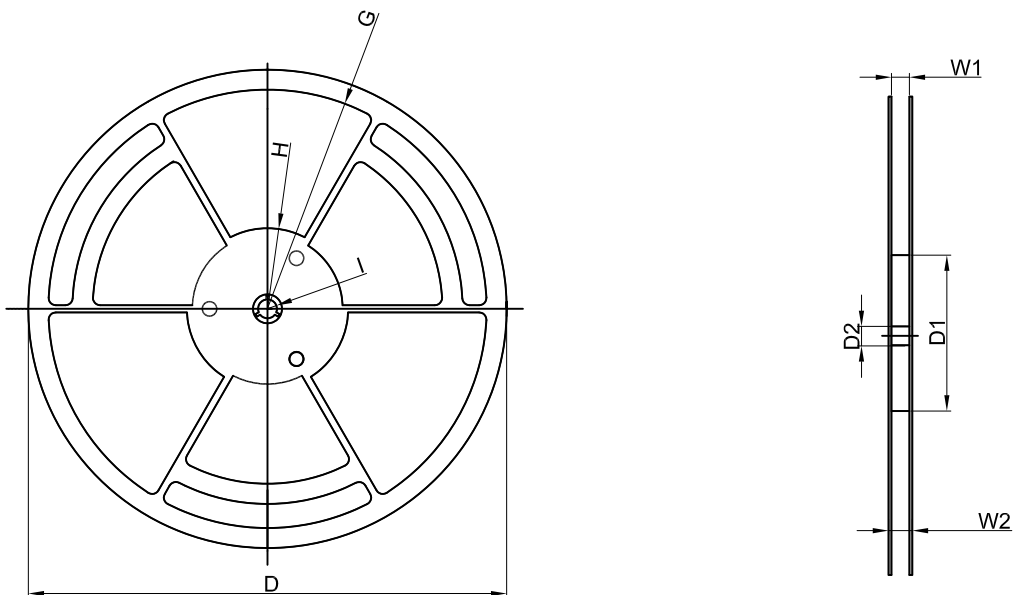

| Dimensions are in millimeter |         |        |       |         |        |       |       |       |
|------------------------------|---------|--------|-------|---------|--------|-------|-------|-------|
| Reel Option                  | D       | D1     | D2    | G       | H      | I     | W1    | W2    |
| 13" Dia                      | Ø330.00 | 100.00 | 13.00 | R151.00 | R56.00 | R6.50 | 12.40 | 17.60 |

| REEL      | Reel Size | Box       | Box Size(mm) | Carton     | Carton Size(mm) | G.W.(kg) |
|-----------|-----------|-----------|--------------|------------|-----------------|----------|
| 4,000 pcs | 13 inch   | 8,000 pcs | 360×360×65   | 64,000 pcs | 565×380×390     |          |