

## TO-220F Plastic-Encapsulate MOSFETS

### CJPF04N60A N-Channel Power MOSFET

$V_{(BR)DSS}$	$R_{DS(on)MAX}$	$I_D$
600V	3Ω@10V	4A

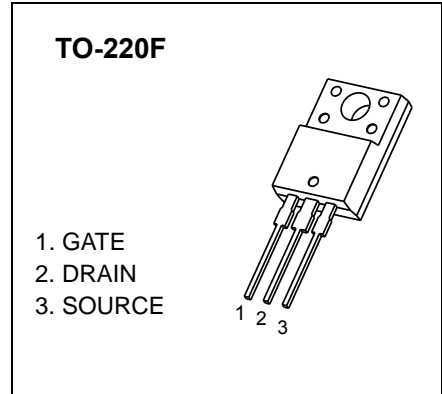

#### GENERAL DESCRIPTION

This advanced high voltage MOSFET is designed to stand high energy in the avalanche mode and switch efficiently. This new high energy device also offers a drain-to-source diode fast recovery time. Designed for high voltage, high speed switching applications such as power supplies, converters, power motor controls and bridge circuits.

#### FEATURE

- High Current Rating
- Lower  $R_{DS(on)}$
- Lower Capacitance
- Lower Total Gate Charge
- Tighter  $V_{SD}$  Specifications
- Avalanche Energy Specified

#### MARKING



CJPF04N60A= Device code  
Solid dot = Green molding compound device,  
if none, the normal device  
XXX=Date Code

#### EQUIVALENT CIRCUIT

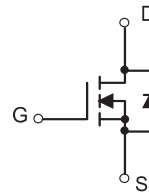

#### Maximum ratings ( $T_a=25^\circ\text{C}$ unless otherwise noted)

Parameter	Symbol	Value	Unit
Drain-Source Voltage	$V_{DS}$	600	V
Gate-Source Voltage	$V_{GS}$	±30	
Continuous Drain Current	$I_D$	4.0	A
Pulsed Drain Current	$I_{DM}$	16	
Single Pulsed Avalanche Energy (note1)	$E_{AS}$	260	mJ
Thermal Resistance from Junction to Ambient	$R_{\theta JA}$	62.5	°C/W
Operating and Storage Temperature Range	$T_J, T_{STG}$	-55 ~+150	°C
Maximum lead temperature for soldering purposes , 1/8"from case for 5 seconds	$T_L$	260	

## MOSFET ELECTRICAL CHARACTERISTICS

$T_a=25^\circ\text{C}$  unless otherwise specified

Parameter	Symbol	Test Condition	Min	Typ	Max	Unit
<b>Off characteristics</b>						
Drain-source breakdown voltage	$V_{(BR)DSS}$	$V_{GS} = 0V, I_D = 250\mu A$	600			V
Drain-source diode forward voltage(note2)	$V_{SD}$	$V_{GS} = 0V, I_S = 4.0A$			1.5	
Zero gate voltage drain current	$I_{DSS}$	$V_{DS} = 600V, V_{GS} = 0V$			25	$\mu A$
Gate-body leakage current (note2)	$I_{GSS}$	$V_{DS} = 0V, V_{GS} = \pm 30V$			$\pm 100$	nA
<b>On characteristics (note2)</b>						
Gate-threshold voltage	$V_{GS(th)}$	$V_{DS} = V_{GS}, I_D = 250\mu A$	2.0	3.0	4.0	V
Static drain-source on-resistance	$R_{DS(on)}$	$V_{GS} = 10V, I_D = 2.0A$		2.2	3.0	$\Omega$
Forward transconductance	$g_{fs}$	$V_{DS} = 50V, I_D = 2A$	2.5			S
<b>Dynamic characteristics (note 3)</b>						
Input capacitance	$C_{iss}$	$V_{DS} = 25V, V_{GS} = 0V, f = 1MHz$			760	pF
Output capacitance	$C_{oss}$				180	
Reverse transfer capacitance	$C_{rss}$				20	
<b>Switching characteristics (note 3)</b>						
Total gate charge	$Q_g$	$V_{DS} = 480V, V_{GS} = 10V, I_D = 4.0A$		5.0	10	nC
Gate-source charge	$Q_{gs}$			2.7		
Gate-drain charge	$Q_{gd}$			2.0		
Turn-on delay time (note3)	$t_{d(on)}$	$V_{DD} = 300V, V_{GS} = 10V,$ $R_G = 9.1\Omega, I_D = 4.0A$			20	ns
Turn-on rise time (note3)	$t_r$				10	
Turn-off delay time (note3)	$t_{d(off)}$				40	
Turn-off fall time (note3)	$t_f$				20	

### Notes :

- $L=30mH, I_L=4A, V_{DD}=100V, V_{GS}=10V, R_G=25\Omega, \text{Starting } T_J=25^\circ\text{C}.$
- Pulse Test : Pulse width  $\leq 300\mu s$ , duty cycle  $\leq 2\%$ .
- These parameters have no way to verify.

# Typical Characteristics

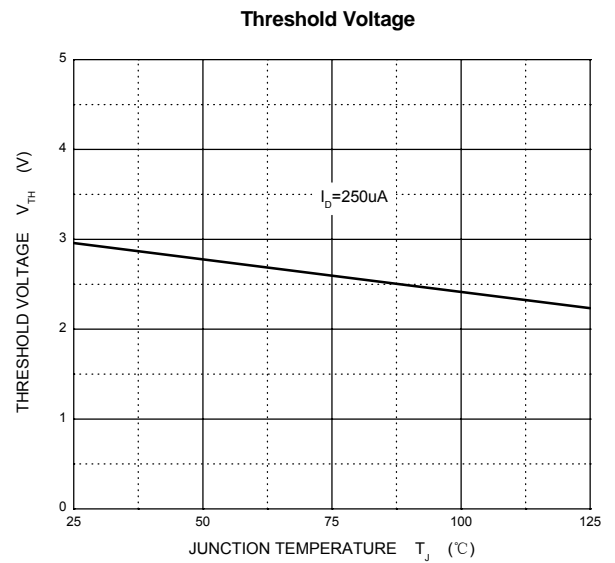
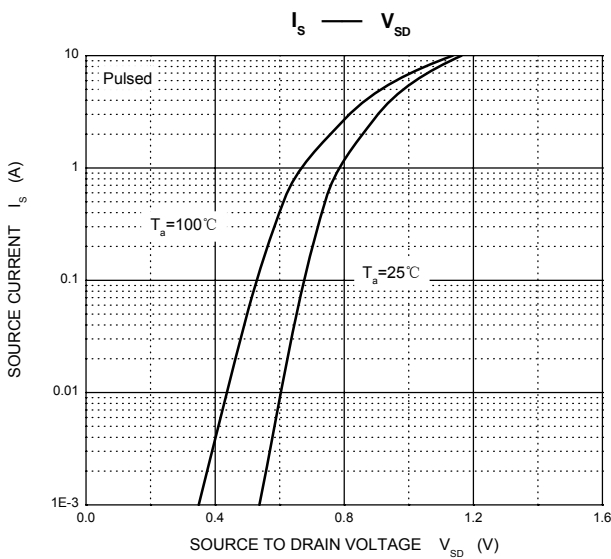
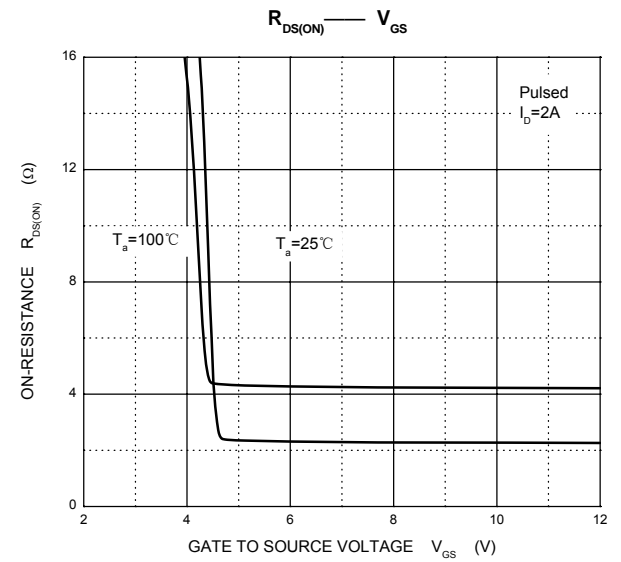
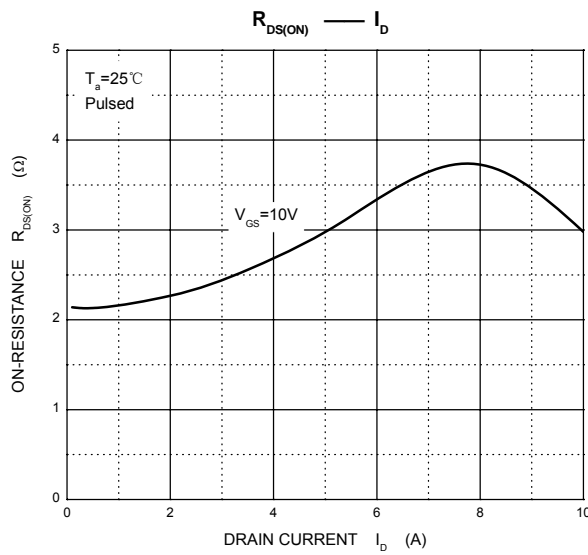
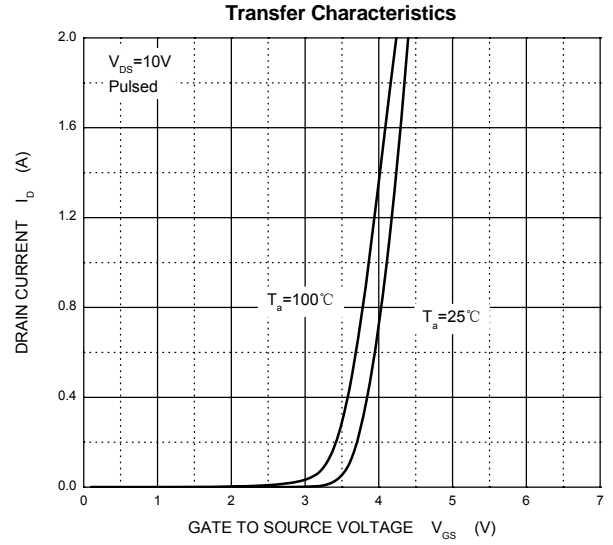
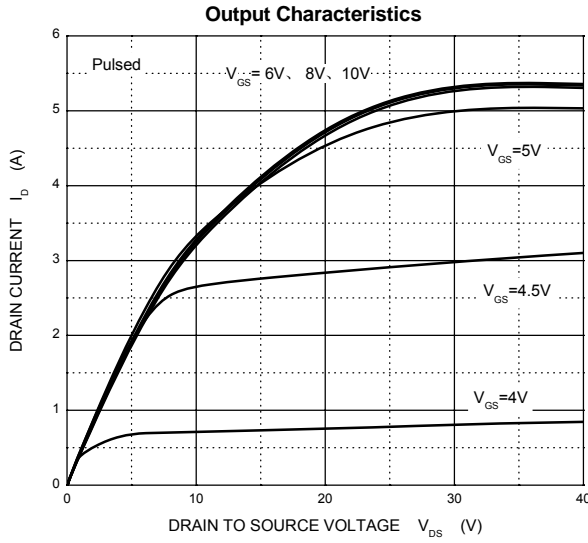

# TO-220F Package Outline Dimensions

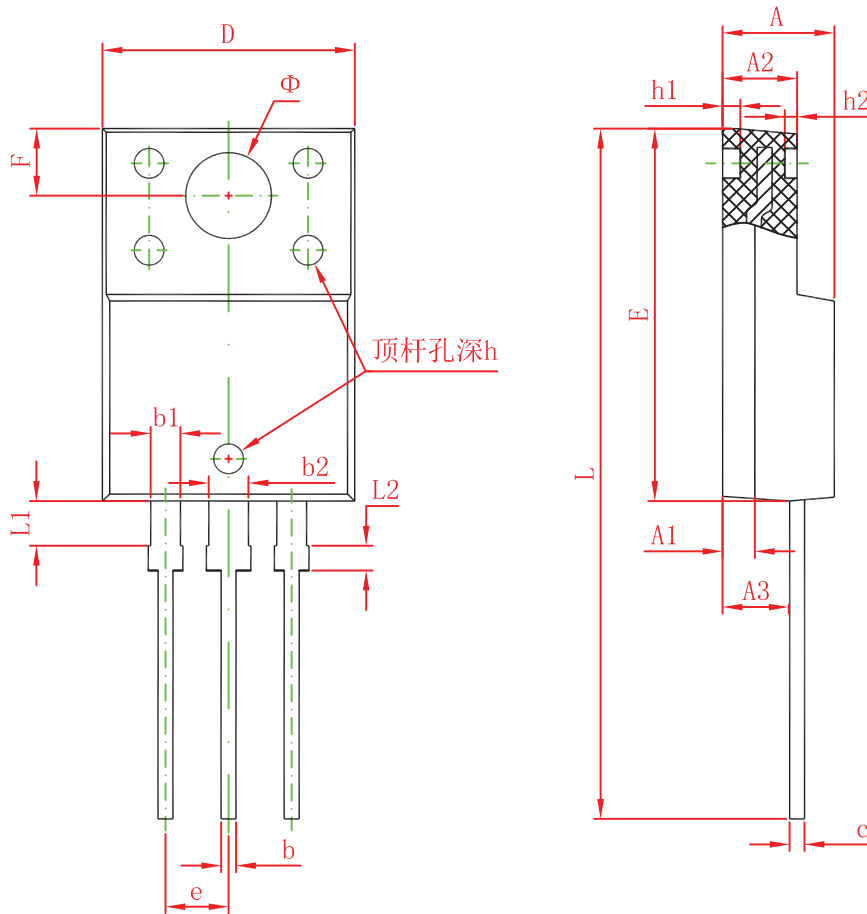

Symbol	Dimensions In Millimeters		Dimensions In Inches	
	Min.	Max.	Min.	Max.
A	4.300	4.700	0.169	0.185
A1	1.300 REF.		0.051 REF.	
A2	2.800	3.200	0.110	0.126
A3	2.500	2.900	0.098	0.114
b	0.500	0.750	0.020	0.030
b1	1.100	1.350	0.043	0.053
b2	1.500	1.750	0.059	0.069
c	0.500	0.750	0.020	0.030
D	9.960	10.360	0.392	0.408
E	14.800	15.200	0.583	0.598
e	2.540 TYP.		0.100 TYP.	
F	2.700 REF.		0.106 REF.	
Φ	3.500 REF.		0.138 REF.	
h	0.000	0.300	0.000	0.012
h1	0.800 REF.		0.031 REF.	
h2	0.500 REF.		0.020 REF.	
L	28.000	28.400	1.102	1.118
L1	1.700	1.900	0.067	0.075
L2	0.900	1.100	0.035	0.043