

TO-251-3L Plastic-Encapsulate MOSFETS

CJD02N65 N-Channel Power MOSFET

GENERAL DESCRIPTION

This advanced high voltage MOSFET is designed to stand high energy in the avalanche mode and switch efficiently. This new high energy device also offers a drain-to-source diode fast recovery time. Designed for high voltage, high speed switching applications such as power supplies, converters, power motor controls and bridge circuits.

FEATURE

- High Current Rating
- Lower $R_{DS(on)}$
- Lower Capacitance
- Lower Total Gate Charge
- Tighter V_{SD} Specifications
- Avalanche Energy Specified

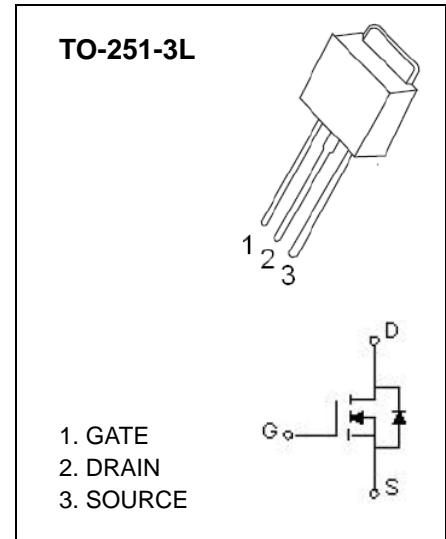

Maximum ratings ($T_a=25^{\circ}\text{C}$ unless otherwise noted)

Parameter	Symbol	Value	Unit
Drain-Source Voltage	V_{DS}	650	V
Gate-Source Voltage	V_{GSS}	± 20	
Continuous Drain Current	I_D	2	A
Pulsed Drain Current	I_{DM}	8	
Single Pulsed Avalanche Energy (note1)	E_{AS}	128	mJ
Power Dissipation	P_D	1.25	W
Thermal Resistance from Junction to Ambient	$R_{\theta JA}$	100	$^{\circ}\text{C}/\text{W}$
Operating and Storage Temperature Range	T_J, T_{STG}	-55 ~ +150	$^{\circ}\text{C}$
Maximum lead temperature for soldering purposes , 1/8"from case for 5 seconds	T_L	260	

Electrical characteristics (T_a=25°C unless otherwise noted)

Parameter	Symbol	Test Condition	Min	Typ	Max	Unit
Off characteristics						
Drain-source breakdown voltage	V _{(BR)DSS}	V _{GS} = 0V, I _D =250μA	650			V
Drain-source diode forward voltage(note2)	V _{SD}	V _{GS} = 0V, I _S =2A			1.6	
Zero gate voltage drain current	I _{DSS}	V _{DS} =600V, V _{GS} =0V			250	μA
Gate-body leakage curren (note2)	I _{GSS}	V _{DS} =0V, V _{GS} = ±20V			±100	nA
On characteristics (note2)						
Gate-threshold voltage	V _{GS(th)}	V _{DS} =V _{GS} , I _D =250μA	2.0		4.0	V
Static drain-source on-resistance	R _{DS(on)}	V _{GS} =10V, I _D =1A			4.4	Ω
Dynamic characteristics (note 3)						
Input capacitance	C _{ISS}	V _{DS} =25V, V _{GS} =0V, f =1MHz		435		pF
Output capacitance	C _{OSS}			56		
Reverse transfer capacitance	C _{RSS}			9.2		
Switching characteristics (note 3)						
Total gate charge	Q _g	V _{DS} =480V, V _{GS} =10V, I _D =4.0A		5.0	10	nC
Gate-source charge	Q _{gs}			2.7		
Gate-drain charge	Q _{gd}			2.0		
Turn-on delay time (note3)	t _{d(on)}	V _{DD} =300V, V _{GS} =10V, R _G =18Ω, I _D =2A		12		ns
Turn-on rise time (note3)	t _r			21		
Turn-off delay time (note3)	t _{d(off)}			30		
Turn-off fall time (note3)	t _f			24		

Notes :

1. L=64mH, I_L=2 A, V_{DD}=50V, R_G=25Ω, Starting T_J=25°C.
2. Pulse Test : Pulse width≤300μs, duty cycle ≤2%.
3. These parameters have no way to verify.

Typical Characteristics

CJD02N65

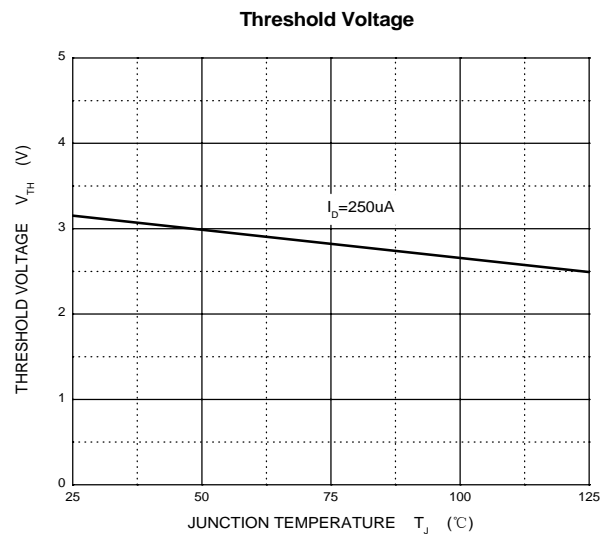
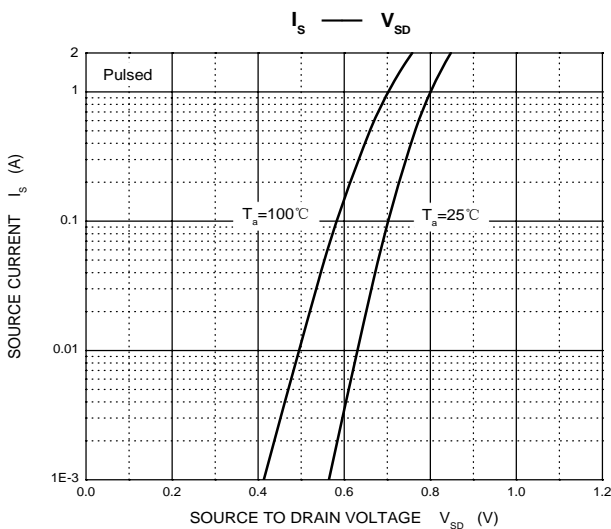
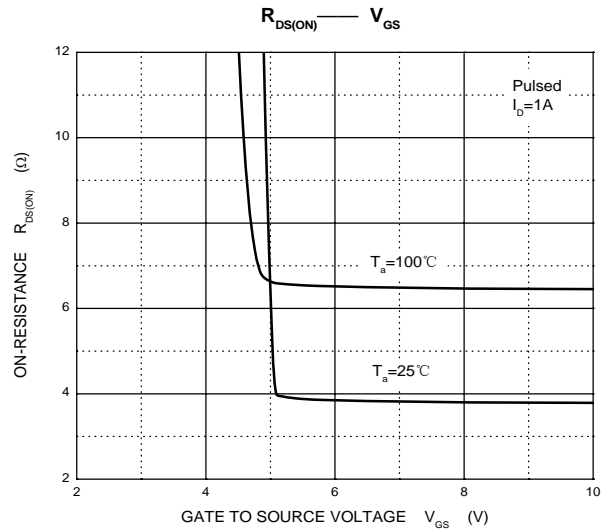
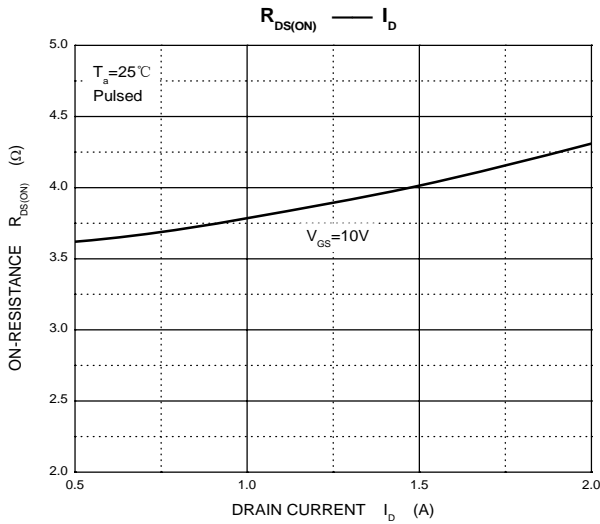
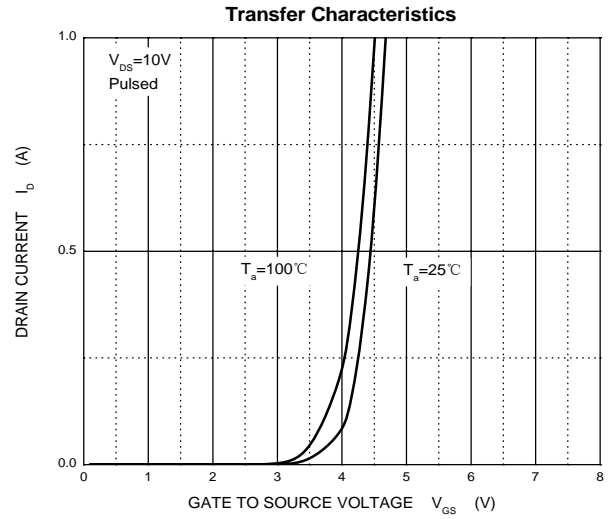
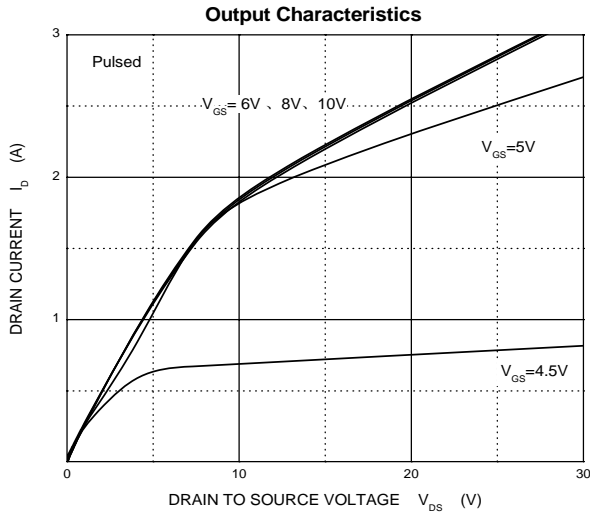

TO-251-3L Package Outline Dimensions

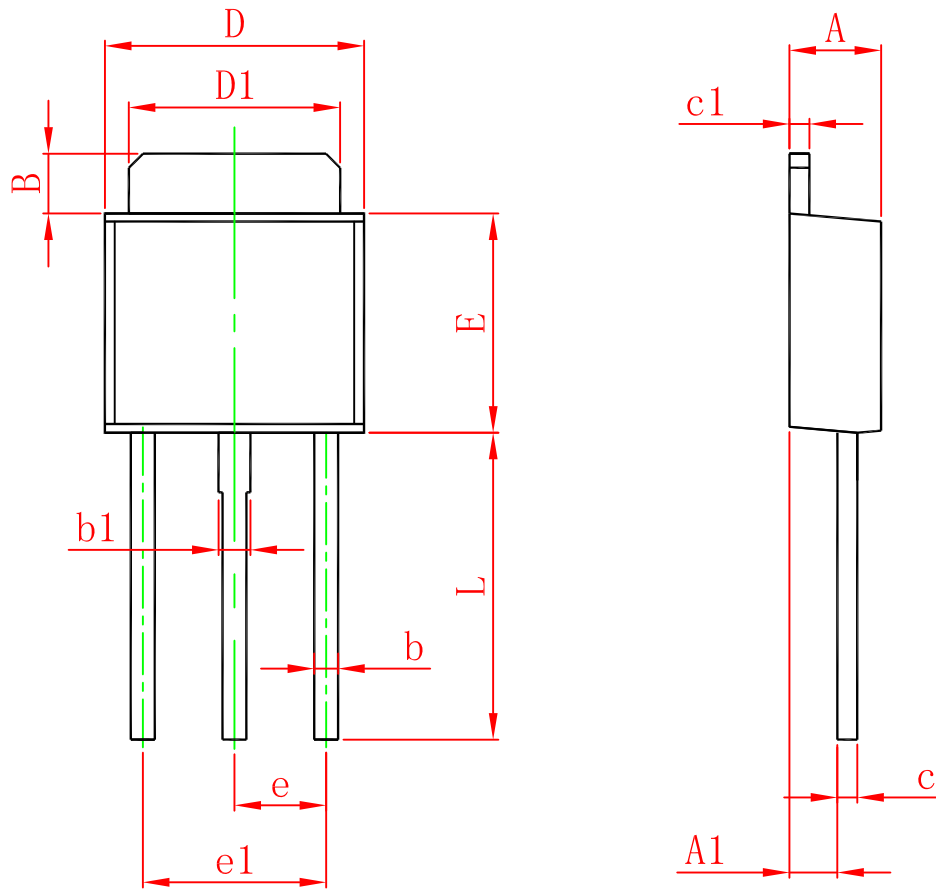

Symbol	Dimensions In Millimeters		Dimensions In Inches	
	Min.	Max.	Min.	Max.
A	2.200	2.400	0.087	0.094
A1	1.050	1.350	0.042	0.054
B	1.350	1.650	0.053	0.065
b	0.500	0.700	0.020	0.028
b1	0.700	0.900	0.028	0.035
c	0.430	0.580	0.017	0.023
c1	0.430	0.580	0.017	0.023
D	6.350	6.650	0.250	0.262
D1	5.200	5.400	0.205	0.213
E	5.400	5.700	0.213	0.224
e	2.300 TYP.		0.091 TYP.	
e1	4.500	4.700	0.177	0.185
L	7.500	7.900	0.295	0.311