

**TO-92 Plastic-Encapsulate Voltage Regulators**

**CJ79L15** Three-terminal negative voltage regulator

**FEATURES**

- Maximum output current  
I<sub>OM</sub>: 0.1A
- Output voltage  
V<sub>O</sub>: -1.5 V
- Continuous total dissipation  
P<sub>D</sub>:0.625 W (T<sub>a</sub>= 25 °C)

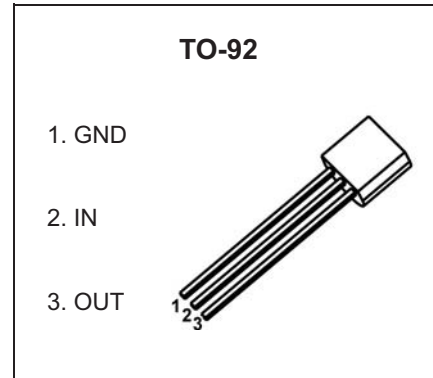

**MARKING**

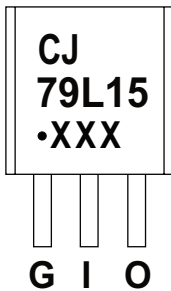

CJ79L15=Device code  
 Solid dot=Green molding compound device,  
 if none,the normal device  
 XXX=Code

**ORDERING INFORMATION**

Part Number	Package	Packing Method	Pack Quantity
CJ79L15	TO-92	Bulk	1000pcs/Bag
CJ79L15-TA	TO-92	Tape	2000pcs/Box

**ABSOLUTE MAXIMUM RATINGS (Operating temperature range applies unless otherwise specified)**

Parameter	Symbol	Value	Unit
Input Voltage	V <sub>i</sub>	-35	V
Thermal Resistance from Junction to Ambient	R <sub>θJA</sub>	200	°C/W
Operating Junction Temperature Range	T <sub>OPR</sub>	0~+150	°C
Storage Temperature Range	T <sub>STG</sub>	-65~+150	°C

# ELECTRICAL CHARACTERISTICS

$T_a=25^\circ\text{C}$  unless otherwise specified ( $V_i=-23\text{V}$ ,  $I_o=40\text{mA}$ ,  $C_i=0.33\mu\text{F}$ ,  $C_o=0.1\mu\text{F}$ , unless otherwise specified).

Parameter	Symbol	Test conditions	Min	Typ	Max	Unit	
Output voltage	$V_o$	$25^\circ\text{C}$	-14.4	-15	-15.6	V	
		-17.5V $\leq V_i \leq$ -30V, $I_o=1\text{mA}\sim 40\text{mA}$	0-125 $^\circ\text{C}$	-14.25	-15	-15.75	V
				$I_o=1\text{mA}\sim 70\text{mA}$	-14.25	-15	-15.75
Load Regulation	$\Delta V_o$	$I_o=1\text{mA}\sim 100\text{mA}$ , $V_i=-23\text{V}$	$25^\circ\text{C}$	25	150	mV	
		$I_o=1\text{mA}\sim 40\text{mA}$ , $V_i=-23\text{V}$	$25^\circ\text{C}$	15	75	mV	
Line regulation	$\Delta V_o$	-17.5V $\leq V_i \leq$ -30V, $I_o=40\text{mA}$	$25^\circ\text{C}$	65	300	mV	
		-20V $\leq V_i \leq$ -30V, $I_o=40\text{mA}$	$25^\circ\text{C}$	50	250	mV	
Quiescent Current	$I_q$		$25^\circ\text{C}$		6.5	mA	
Quiescent Current Change	$\Delta I_q$	-20V $\leq V_i \leq$ -30V, $I_o=40\text{mA}$	0-125 $^\circ\text{C}$		1.5	mA	
	$\Delta I_q$	$1\text{mA} \leq I_o \leq 40\text{mA}$	0-125 $^\circ\text{C}$		0.1	mA	
Output Noise Voltage	$V_N$	10Hz $\leq f \leq$ 100KHz	$25^\circ\text{C}$	90		$\mu\text{V}/V_o$	
Ripple Rejection	RR	-18.5V $\leq V_i \leq$ -28.5V, $f=120\text{Hz}$	0-125 $^\circ\text{C}$	34	39	dB	
Dropout Voltage	$V_d$		$25^\circ\text{C}$	1.7		V	

\* Pulse test.

## TYPICAL APPLICATION

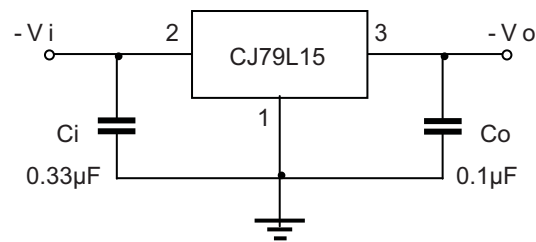

Note: Bypass capacitors are recommended for optimum stability and transient response and should be located as close as possible to the regulators.

# Typical Characteristics

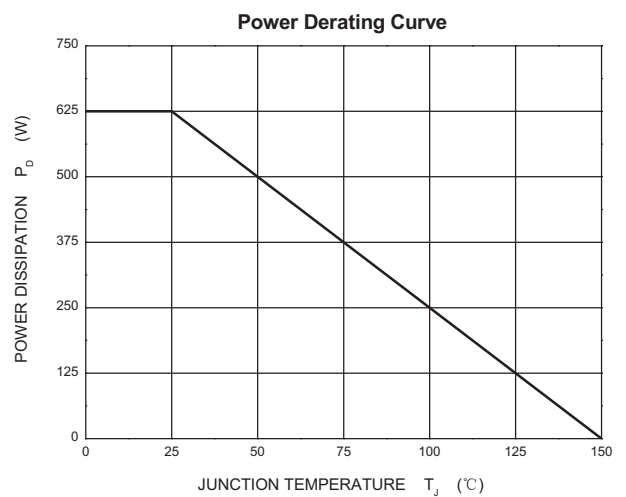
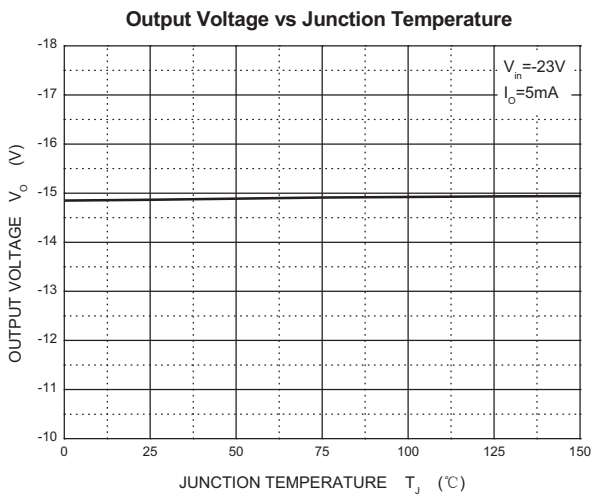
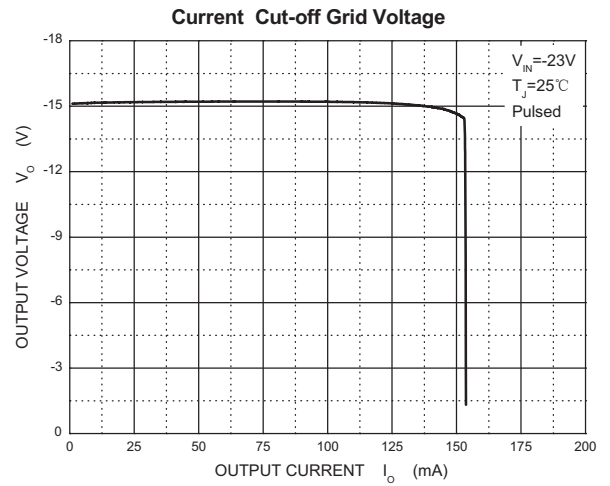
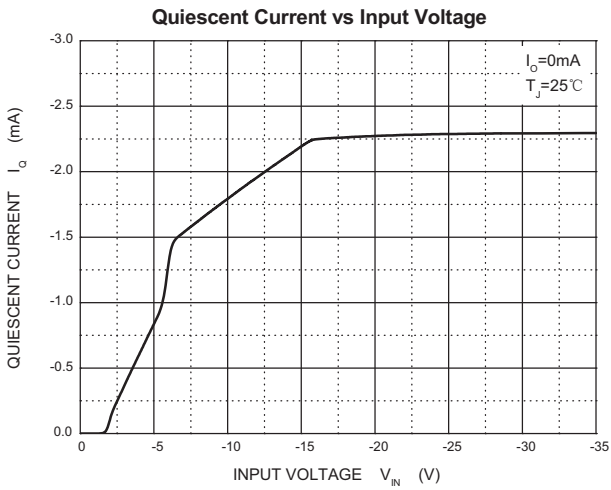
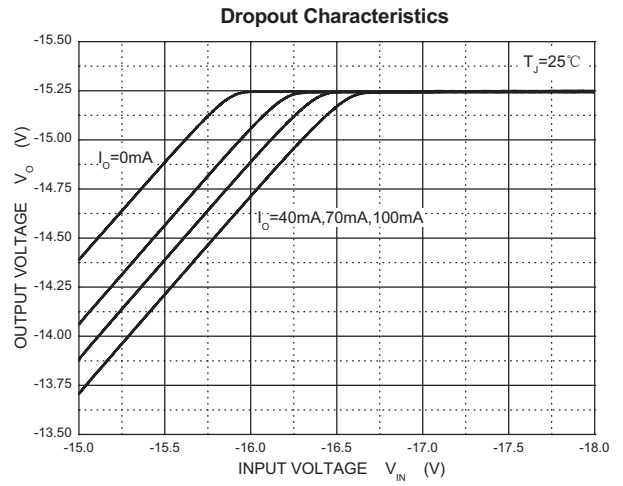
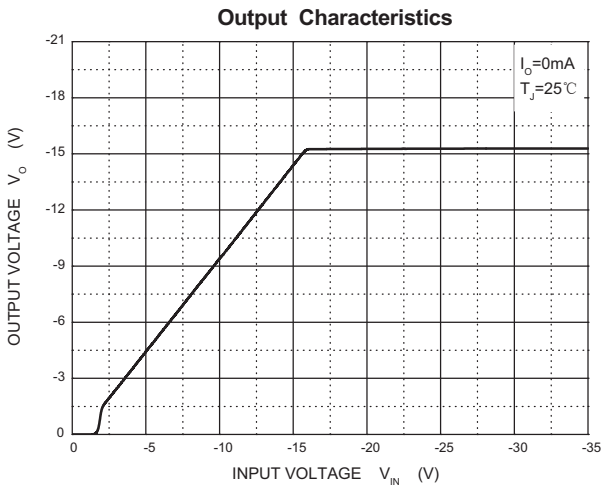

## TO-92 Package Outline Dimensions

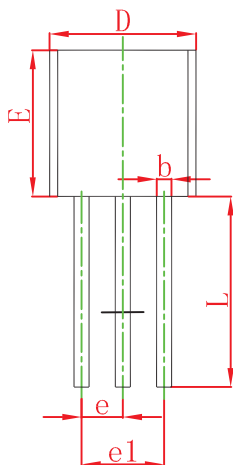
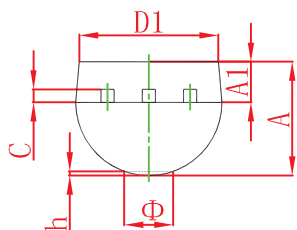

Symbol	Dimensions In Millimeters		Dimensions In Inches	
	Min	Max	Min	Max
A	3.300	3.700	0.130	0.146
A1	1.100	1.400	0.043	0.055
b	0.380	0.550	0.015	0.022
c	0.360	0.510	0.014	0.020
D	4.400	4.700	0.173	0.185
D1	3.430		0.135	
E	4.300	4.700	0.169	0.185
e	1.270 TYP		0.050 TYP	
e1	2.440	2.640	0.096	0.104
L	14.100	14.500	0.555	0.571
Φ		1.600		0.063
h	0.000	0.380	0.000	0.015

## TO-92 Suggested Pad Layout

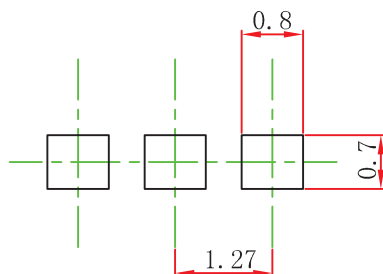

### Note:

1. Controlling dimension: in millimeters.
2. General tolerance:  $\pm 0.05\text{mm}$ .
3. The pad layout is for reference purposes only.

### NOTICE

JCET reserve the right to make modifications, enhancements, improvements, corrections or other changes without further notice to any product herein. JCET does not assume any liability arising out of the application or use of any product described herein.

# TO-92 PACKAGE TAPEING DIMENSION

## TO-92 PACKAGE TAPEING DIMENSION

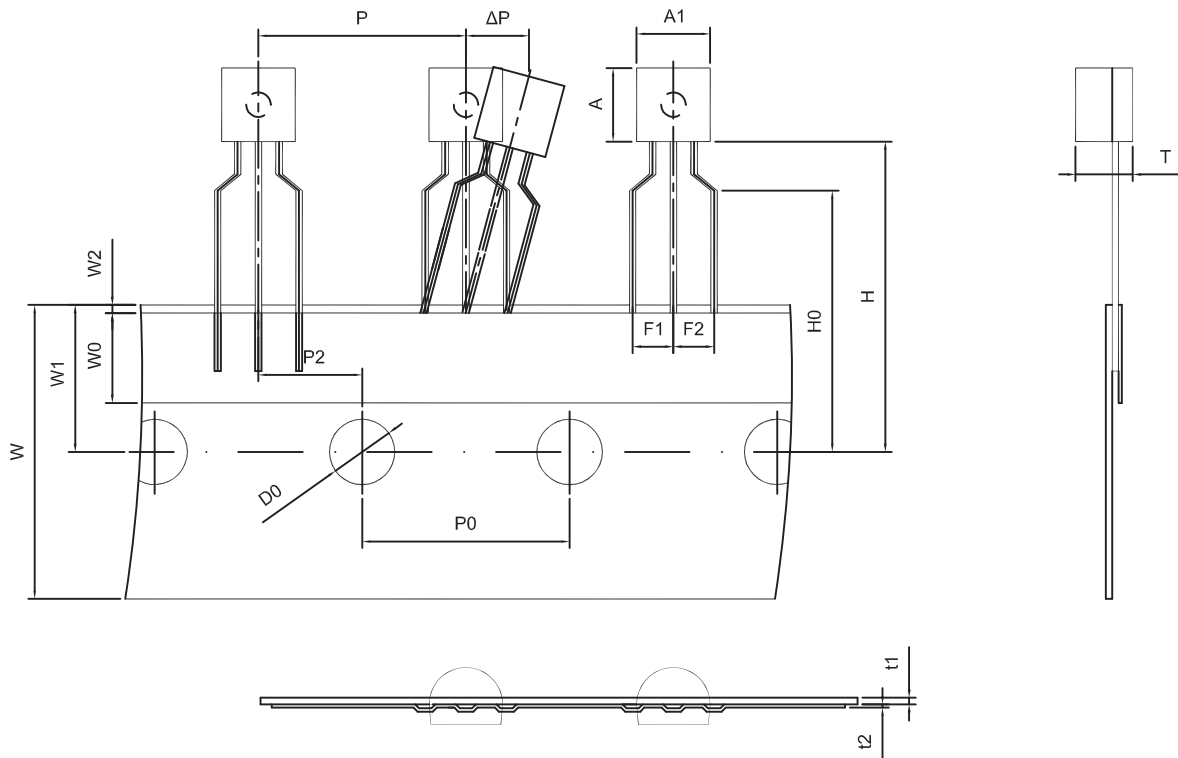

Dimensions are in millimeter

A1	A	T	P	P0	P2	F1	F2	W
4.5	4.5	3.5	12.7	12.7	6.35	2.5	2.5	18.0
W0	W1	W2	H	H0	D0	t1	t2	ΔP
6.0	9.0	1.0 MAX.	19.0	16.0	4.0	0.4	0.2	0

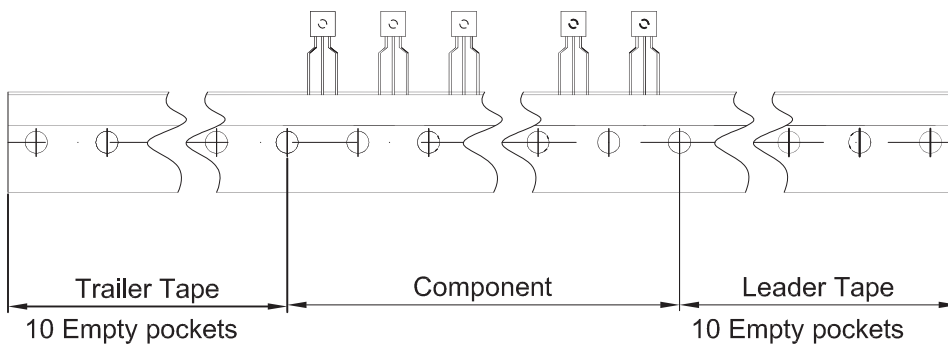

Package	Box	Box Size(mm)	Carton	Carton Size(mm)
TO-92	2000 pcs	333×162×43	20,000 pcs	350×340×250