

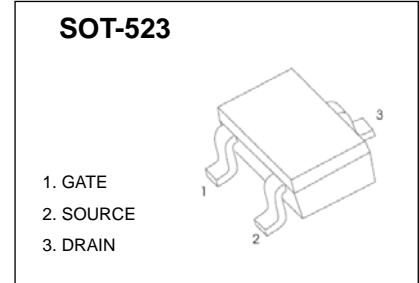

## SOT-523 Plastic-Encapsulate MOSFETS

### **CJ4153** N-Channel 20-V(D-S) MOSFET

$V_{(BR)DSS}$	$R_{DS(on)MAX}$	$I_D$
20V	570mΩ@4.5V	0.915A
	620mΩ@2.5V	
	700mΩ@1.8V	
	1500mΩ@1.5V	



#### FEATURE

- Low  $R_{DS(on)}$  Improving System Efficiency
- Low Threshold Voltage ,1.5V Rated
- ESD Protected Gate
- Pb-Free Packages are Available

#### APPLICATION

- Load/Power Switches
- Power Supply Converter Circuits
- Battery Management
- Portables like Cell Phones, PDAs, Digital Cameras, Pagers,etc

#### MARKING

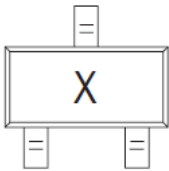

#### Equivalent Circuit

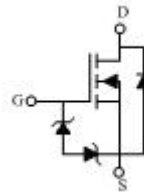

#### Maximum ratings ( $T_a=25^{\circ}C$ unless otherwise noted)

Parameter	Symbol	Value	Unit
Drain-Source Voltage	$V_{DS}$	20	V
Gate-Source Voltage	$V_{GS}$	±6	
Continuous Drain Current (note 1)	$I_D$	0.915	A
Power Dissipation (note 1)	$P_D$	150	mW
Thermal Resistance from Junction to Ambient (note 1)	$R_{\theta JA}$	833	$^{\circ}C/W$
Operating Junction Temperature	$T_J$	150	$^{\circ}C$
Storage Temperature	$T_{stg}$	-55~+150	

## MOSFET ELECTRICAL CHARACTERISTICS

$T_a=25^\circ\text{C}$  unless otherwise specified

Parameter	Symbol	Test Condition	Min	Typ	Max	Unit
<b>OFF CHARACTERISTICS</b>						
Drain-source breakdown voltage	$V_{(BR)DSS}$	$V_{GS} = 0V, I_D = 250\mu A$	20			V
Gate-source leakage	$I_{GSS}$	$V_{DS} = 0V, V_{GS} = \pm 4.5V$			$\pm 1$	$\mu A$
Zero gate voltage drain current	$I_{DSS}$	$V_{DS} = 16V, V_{GS} = 0V$			100	nA
<b>ON CHARACTERISTICS (note 2)</b>						
Gate-source threshold voltage	$V_{GS(th)}$	$V_{DS} = V_{GS}, I_D = 250\mu A$	0.45	0.8	1.1	V
Drain-source on-state resistance	$R_{DS(on)}$	$V_{GS} = 4.5V, I_D = 600mA$		300	570	m $\Omega$
		$V_{GS} = 2.5V, I_D = 500mA$		380	620	
		$V_{GS} = 1.8V, I_D = 350mA$		550	700	
		$V_{GS} = 1.5V, I_D = 40mA$		600	1500	
Forward transconductance	$g_{fs}$	$V_{DS} = 10V, I_D = 400mA$	0.5			S
<b>CHARGES AND CAPACITANCES (note 3)</b>						
Input Capacitance	$C_{iss}$	$V_{DS} = 16V, V_{GS} = 0V, f = 1MHz$		110		pF
Output Capacitance	$C_{oss}$			16		
Reverse Transfer Capacitance	$C_{rss}$			12		
Total Gate Charge	$Q_g$	$V_{DS} = 10V, V_{GS} = 4.5V, I_D = 200mA$		1.82		nC
Gate-Source Charge	$Q_{gs}$			0.3		
Gate-Drain Charge	$Q_{gd}$			0.42		
<b>SWITCHING CHARACTERISTICS (note 3,4)</b>						
Turn-on delay time	$t_{d(on)}$	$V_{DD} = 10V, V_{GS} = 4.5V, R_G = 10\Omega, I_D = 200mA$		3.7		ns
Rise time	$t_r$			4.4		
Turn-off delay time	$t_{d(off)}$			25		
Fall time	$t_f$			7.6		
<b>DRAIN-SOURCE DIODE CHARACTERISTICS</b>						
Body diode voltage	$V_{SD}$	$I_S = 0.2A, V_{GS} = 0V$			1.1	V

**Notes :**

1. Surface mounted on FR4 board using 1 in sq pad size.
2. Pulse Test : Pulse width  $\leq 300\mu s$ , Duty cycle  $\leq 2\%$ .
3. Guaranteed by design, not subject to production testing.
4. Switching characteristics are independent of operating junction temperatures.

# Typical Characteristics

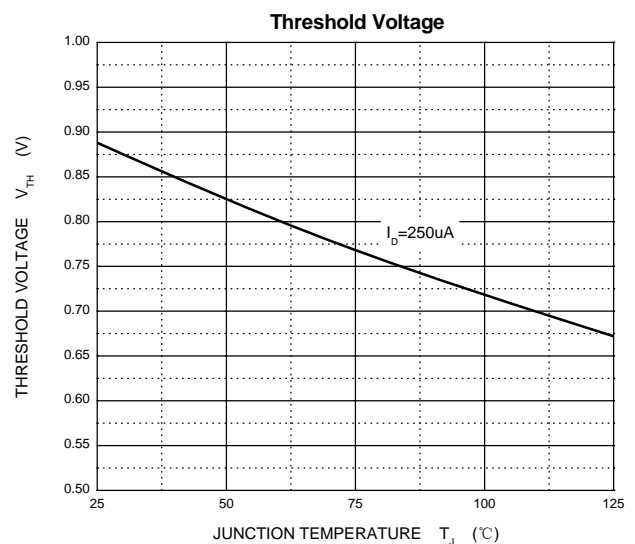
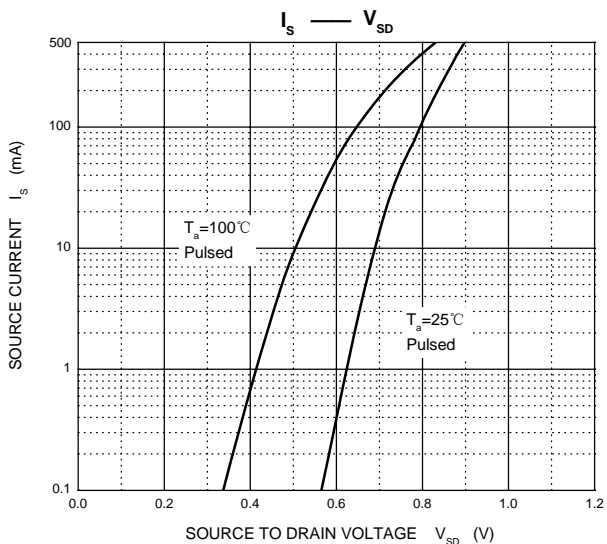
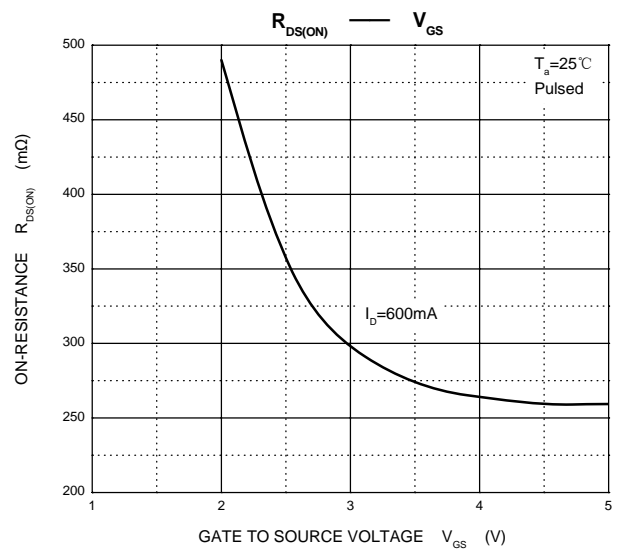
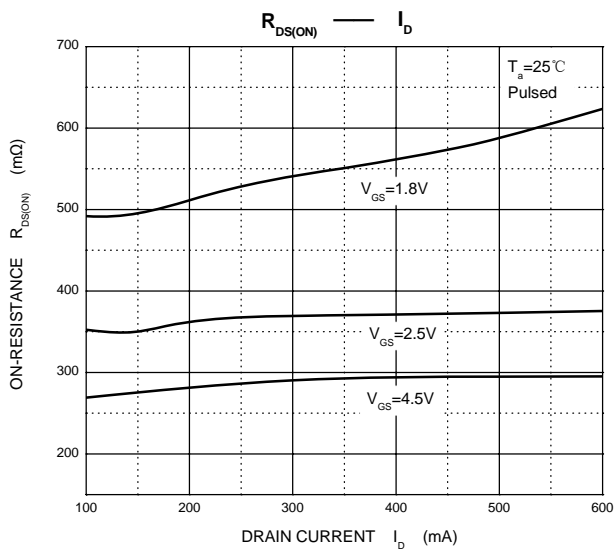
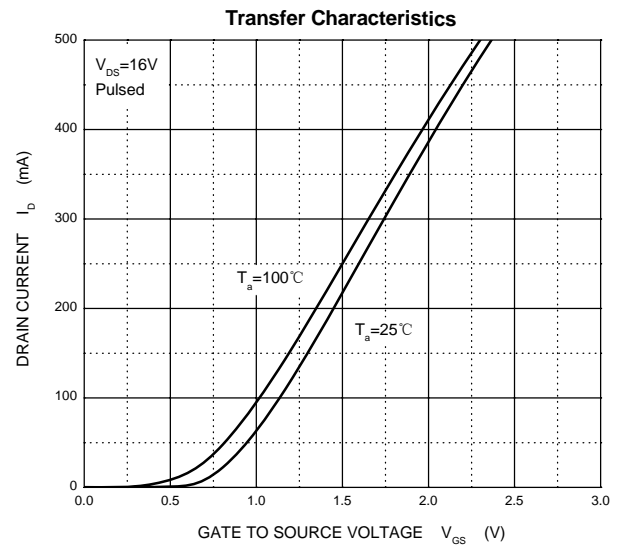
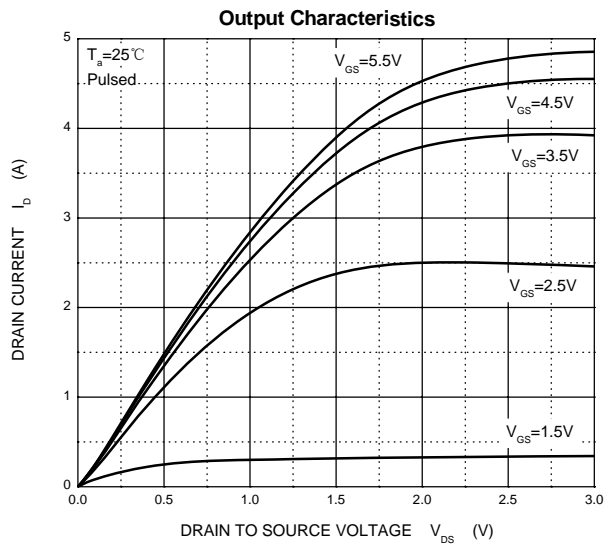

## SOT-523 Package Outline Dimensions

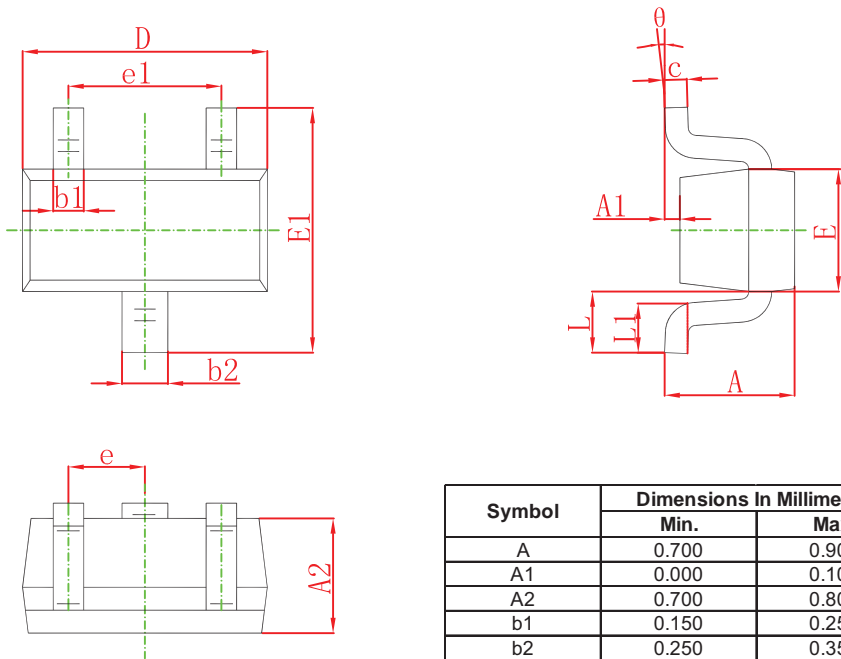

Symbol	Dimensions In Millimeters		Dimensions In Inches	
	Min.	Max.	Min.	Max.
A	0.700	0.900	0.028	0.035
A1	0.000	0.100	0.000	0.004
A2	0.700	0.800	0.028	0.031
b1	0.150	0.250	0.006	0.010
b2	0.250	0.350	0.010	0.014
c	0.100	0.200	0.004	0.008
D	1.500	1.700	0.059	0.067
E	0.700	0.900	0.028	0.035
E1	1.450	1.750	0.057	0.069
e	0.500 TYP.		0.020 TYP.	
e1	0.900	1.100	0.035	0.043
L	0.400 REF.		0.016 REF.	
L1	0.260	0.460	0.010	0.018
θ	0°	8°	0°	8°

## SOT-523 Suggested Pad Layout

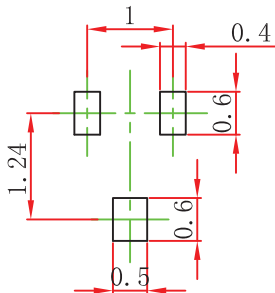

- Note:
1. Controlling dimension: in millimeters.
  2. General tolerance:  $\pm 0.05$  mm.
  3. The pad layout is for reference purposes only.

### NOTICE

JCET reserve the right to make modifications, enhancements, improvements, corrections or other changes without further notice to any product herein. JCET does not assume any liability arising out of the application or use of any product described herein.

## SOT-523 Tape and reel

### SOT-523 Embossed Carrier Tape

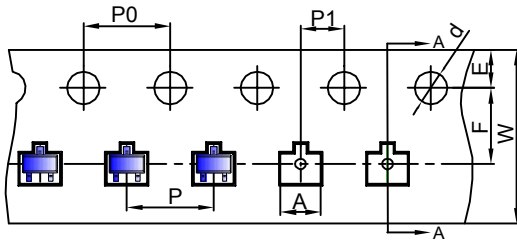

**Packaging Description:**

SOT-523 parts are shipped in tape. The carrier tape is made from a dissipative (carbon filled) polycarbonate resin. The cover tape is a multilayer film (Heat Activated Adhesive in nature) primarily composed of polyester film, adhesive layer, sealant, and anti-static sprayed agent. These reeled parts in standard option are shipped with 3,000 units per 7" or 17.8cm diameter reel. The reels are clear in color and is made of polystyrene plastic (anti-static coated).

Dimensions are in millimeter											
Pkg type	A	B	C	d	E	F	P0	P	P1	W	
SOT-523	1.85	1.85	0.875	Ø1.50	1.75	3.50	4.00	4.00	2.00	8.00	

### SOT-523 Tape Leader and Trailer

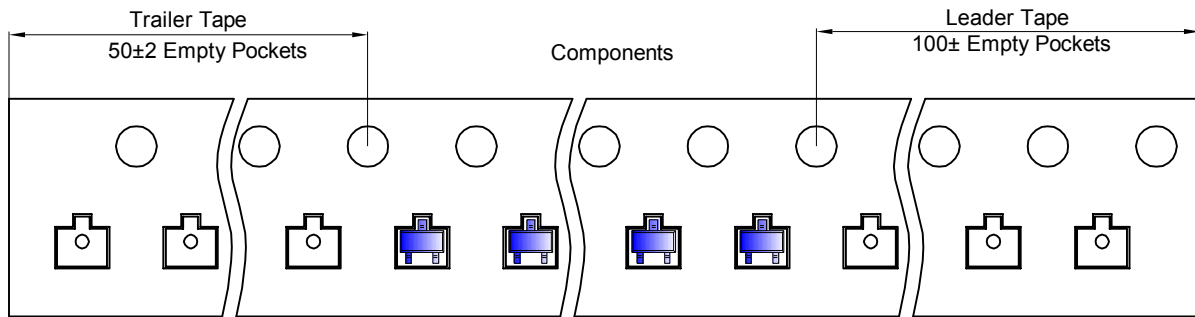

### SOT-523 Reel

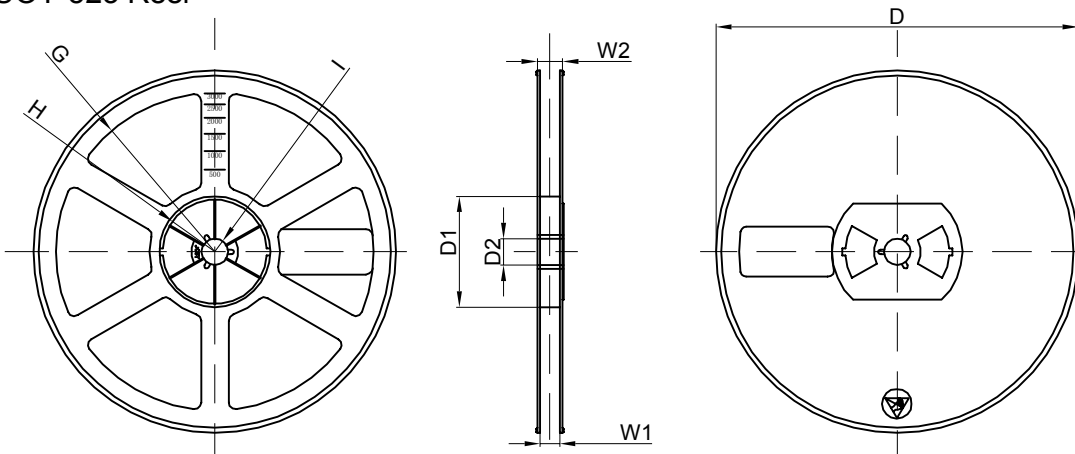

Dimensions are in millimeter								
Reel Option	D	D1	D2	G	H	I	W1	W2
7" Dia	Ø178.00	54.40	13.00	R78.00	R25.60	R6.50	9.50	12.30

REEL	Reel Size	Box	Box Size(mm)	Carton	Carton Size(mm)	G.W.(kg)
3000 pcs	7 inch	30,000 pcs	203×203×195	120,000 pcs	438×438×220	