

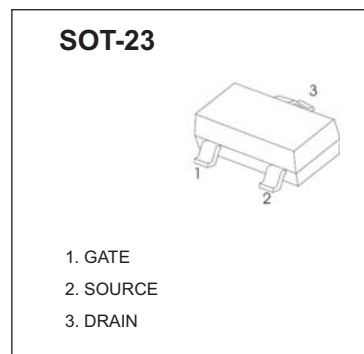

SOT-23 Plastic-Encapsulate MOSFETS

CJ3139K P-Channel MOSFET

$V_{(BR)DSS}$	$R_{DS(on)MAX}$	I_D
-20V	520mΩ@-4.5V	-0.66A
	700mΩ@-2.5V	
	950mΩ(TYP)@-1.8V	



FEATURE

- Lead Free Product is Acquired
- Surface Mount Package
- P-Channel Switch with Low $R_{DS(on)}$
- Operated at Low Logic Level Gate Drive

APPLICATION

- Load/Power Switching
- Interfacing, Logic Switching
- Battery Management for Ultra Small Portable Electronics

MARKING

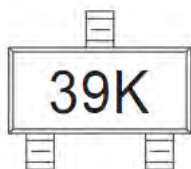

Equivalent Circuit

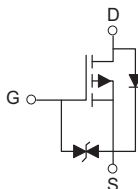

Maximum ratings ($T_a=25^\circ\text{C}$ unless otherwise noted)

Parameter	Symbol	Value	Unit
Drain-Source Voltage	V_{DS}	-20	V
Typical Gate-Source Voltage	V_{GS}	± 12	V
Continuous Drain Current (note 1)	I_D	-0.66	A
Pulsed Drain Current ($t_p=10\ \mu\text{s}$)	I_{DM}	-1.2	A
Power Dissipation (note 1)	P_D	350	mW
Thermal Resistance from Junction to Ambient (note 1)	$R_{\theta JA}$	357	$^\circ\text{C/W}$
Junction Temperature	T_J	150	$^\circ\text{C}$
Storage Temperature	T_{STG}	-55~+150	$^\circ\text{C}$
Lead Temperature for Soldering Purposes(1/8" from case for 10 s)	T_L	260	$^\circ\text{C}$

MOSFET ELECTRICAL CHARACTERISTICS

$T_a=25^\circ\text{C}$ unless otherwise specified

Parameter	Symbol	Test Condition	Min	Typ	Max	Unit
STATIC CHARACTERISTICS						
Drain-source breakdown voltage	$V_{(BR)DSS}$	$V_{GS} = 0V, I_D = -250\mu A$	-20			V
Zero gate voltage drain current	I_{DSS}	$V_{DS} = -20V, V_{GS} = 0V$			-1	μA
Gate-body leakage current	I_{GSS}	$V_{GS} = \pm 10V, V_{DS} = 0V$			± 20	μA
Gate threshold voltage (note 2)	$V_{GS(th)}$	$V_{DS} = V_{GS}, I_D = -250\mu A$	-0.35	-0.45	-1.1	V
Drain-source on-resistance (note 2)	$R_{DS(on)}$	$V_{GS} = -4.5V, I_D = -1A$		430	520	$m\Omega$
		$V_{GS} = -2.5V, I_D = -0.8A$		624	700	$m\Omega$
		$V_{GS} = -1.8V, I_D = -0.5A$		950		$m\Omega$
Forward transconductance (note 2)	g_{FS}	$V_{DS} = -10V, I_D = -0.54A$		1.2		S
Diode forward voltage	V_{SD}	$I_S = -0.5A, V_{GS} = 0V$			-1.2	V
DYNAMIC CHARACTERISTICS (note 4)						
Input capacitance	C_{iss}	$V_{DS} = -16V, V_{GS} = 0V, f = 1MHz$		113	170	pF
Output capacitance	C_{oss}			15	25	pF
Reverse transfer capacitance	C_{rss}			9	15	pF
SWITCHING CHARACTERISTICS (note 4)						
Turn-on delay time (note 3)	$t_{d(on)}$	$V_{GS} = -4.5V, V_{DS} = -10V,$ $I_D = -200mA, R_{GEN} = 10\Omega$		9		ns
Turn-on rise time (note 3)	t_r			5.8		ns
Turn-off delay time (note 3)	$t_{d(off)}$			32.7		ns
Turn-off fall time (note 3)	t_f			20.3		ns

Notes :

1. Surface mounted on FR4 board using the minimum recommended pad size.
2. Pulse Test : Pulse Width=300 μs , Duty Cycle=2%.
3. Switching characteristics are independent of operating junction temperatures.
4. Guaranteed by design, not subject to producing.

Typical Characteristics

Output Characteristics

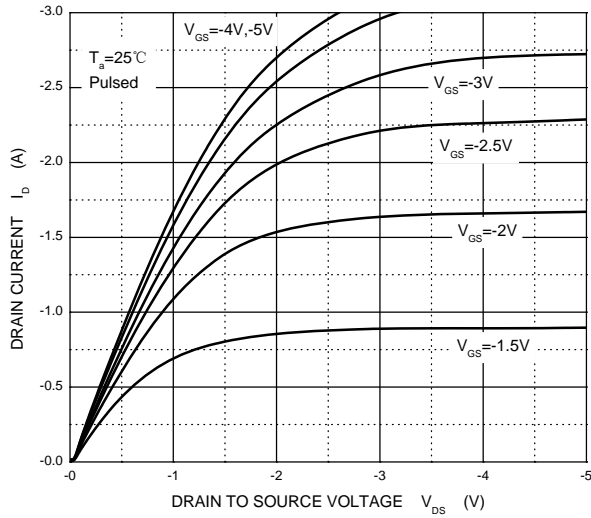

Transfer Characteristics

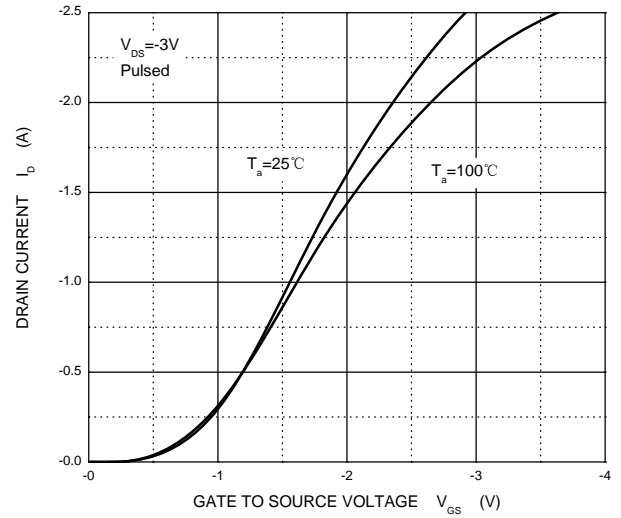

$R_{DS(ON)}$ — I_D

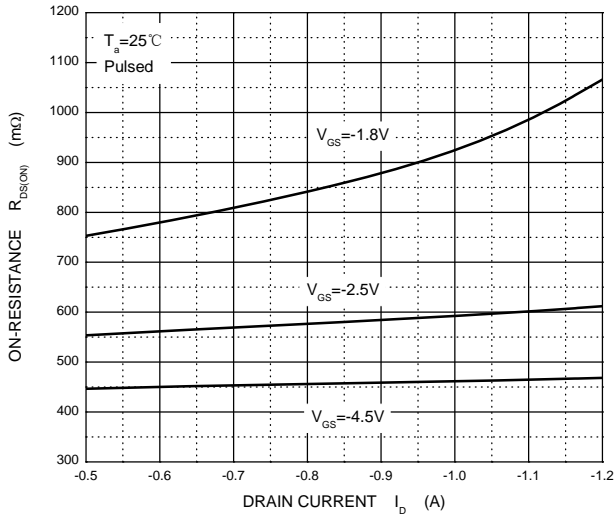

$R_{DS(ON)}$ — V_{GS}

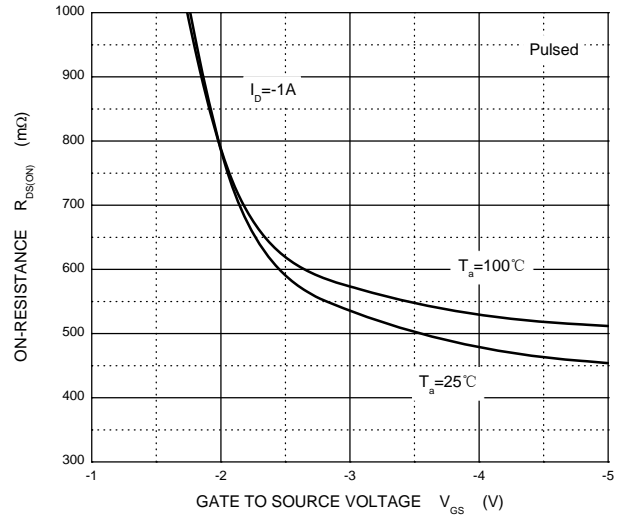

I_S — V_{SD}

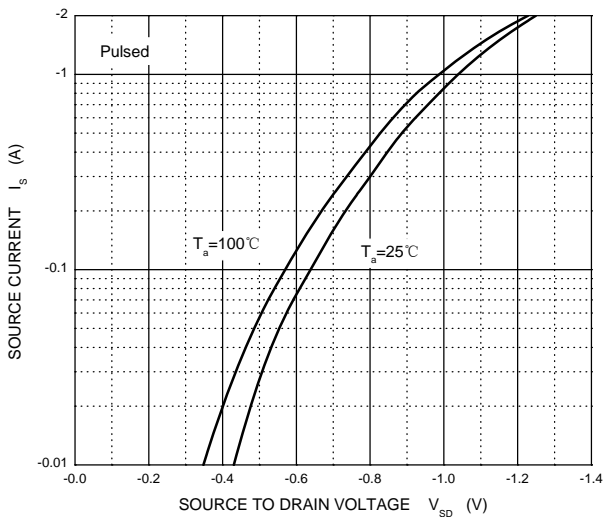

Threshold Voltage

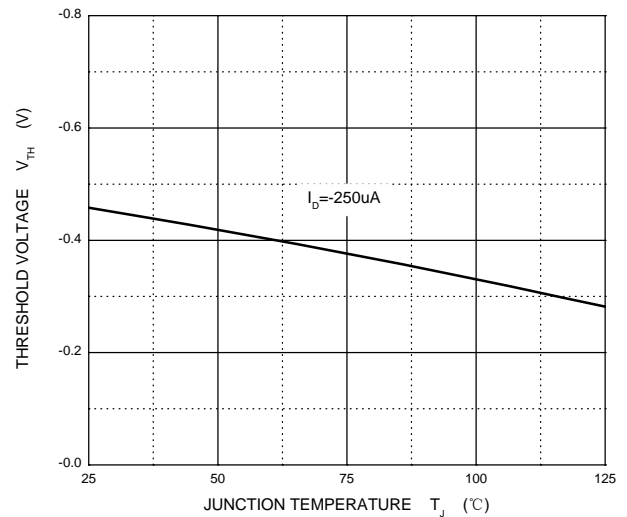

SOT-23 Package Outline Dimensions

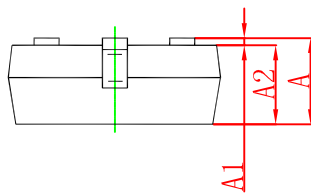
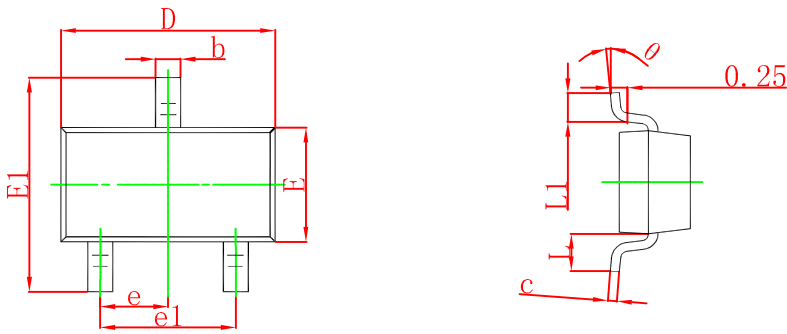

Symbol	Dimensions In Millimeters		Dimensions In Inches	
	Min	Max	Min	Max
A	0.900	1.150	0.035	0.045
A1	0.000	0.100	0.000	0.004
A2	0.900	1.050	0.035	0.041
b	0.300	0.500	0.012	0.020
c	0.080	0.150	0.003	0.006
D	2.800	3.000	0.110	0.118
E	1.200	1.400	0.047	0.055
E1	2.250	2.550	0.089	0.100
e	0.950 TYP		0.037 TYP	
e1	1.800	2.000	0.071	0.079
L	0.550 REF		0.022 REF	
L1	0.300	0.500	0.012	0.020
θ	0°	8°	0°	8°

SOT-23 Suggested Pad Layout



- Note:
1. Controlling dimension: in millimeters.
 2. General tolerance: $\pm 0.05\text{mm}$.
 3. The pad layout is for reference purposes only.

NOTICE

JCET reserve the right to make modifications, enhancements, improvements, corrections or other changes without further notice to any product herein. JCET does not assume any liability arising out of the application or use of any product described herein.

SOT-23 Tape and reel

SOT-23 Embossed Carrier Tape

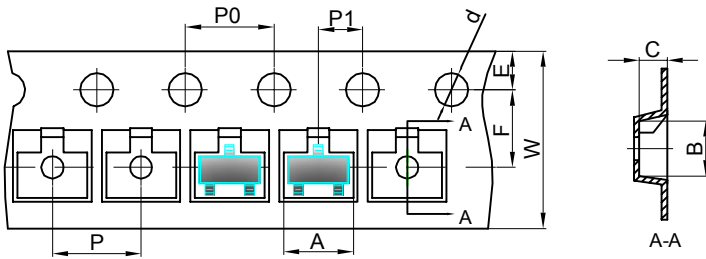

Packaging Description:

SOT-23 parts are shipped in tape. The carrier tape is made from a dissipative (carbon filled) polycarbonate resin. The cover tape is a multilayer film (Heat Activated Adhesive in nature) primarily composed of polyester film, adhesive layer, sealant, and anti-static sprayed agent. These reeled parts in standard option are shipped with 3,000 units per 7" or 17.8cm diameter reel. The reels are clear in color and is made of polystyrene plastic (anti-static coated).

Dimensions are in millimeter										
Pkg type	A	B	C	d	E	F	P0	P	P1	W
SOT-23	3.15	2.77	1.22	Ø1.50	1.75	3.50	4.00	4.00	2.00	8.00

SOT-23 Tape Leader and Trailer

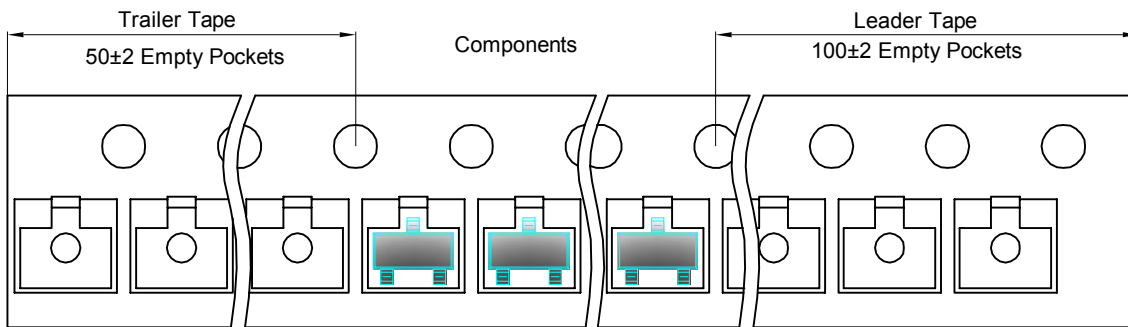

SOT-23 Reel

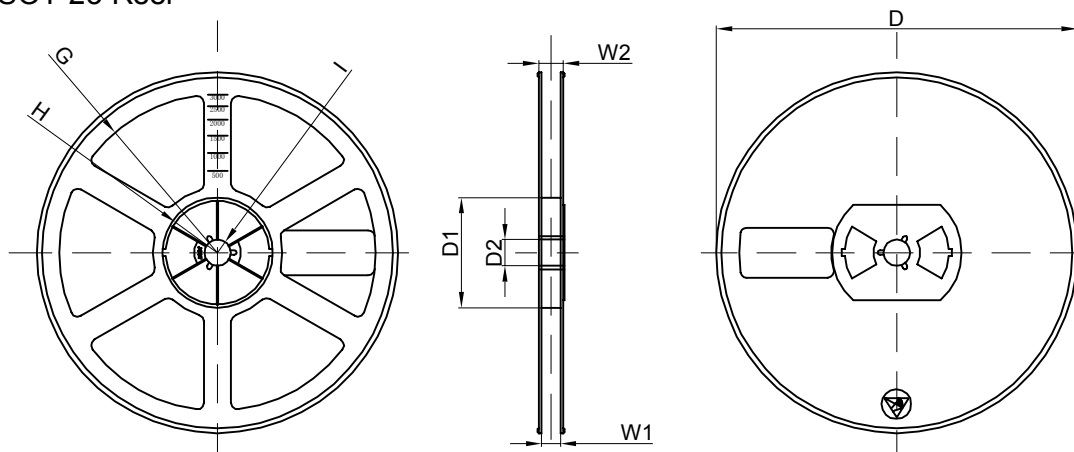

Dimensions are in millimeter								
Reel Option	D	D1	D2	G	H	I	W1	W2
7" Dia	Ø178.00	54.40	13.00	R78.00	R25.60	R6.50	9.50	12.30

REEL	Reel Size	Box	Box Size(mm)	Carton	Carton Size(mm)	G.W.(kg)
3000 pcs	7 inch	30,000 pcs	203×203×195	120,000 pcs	438×438×220	