

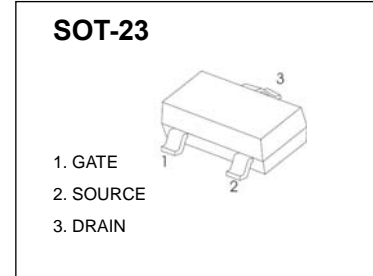

SOT-23 Plastic-Encapsulate MOSFETS

CJ3134K N-Channel MOSFET

| $V_{(BR)DSS}$ | $R_{DS(on)MAX}$ | I_D |
|---------------|-----------------|-------|
| 20V | 380mΩ@4.5V | 0.75A |
| | 450mΩ@2.5V | |
| | 800mΩ@1.8V | |



FEATURES

- Lead Free Product is Acquired
- Surface Mount Package
- N-Channel Switch with Low $R_{DS(on)}$
- Operated at Low Logic Level Gate Drive

APPLICATION

- Load/Power Switching
- Interfacing Switching
- Battery Management for Ultra Small Portable Electronics
- Logic Level Shift

MARKING

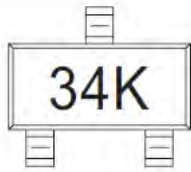

Equivalent Circuit

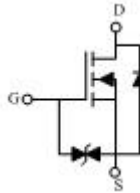

Maximum ratings ($T_a=25^\circ\text{C}$ unless otherwise noted)

| Parameter | Symbol | Value | Unit |
|---|-----------------|----------|--------------------|
| Drain-Source Voltage | V_{DS} | 20 | V |
| Typical Gate-Source Voltage | V_{GS} | ±12 | V |
| Continuous Drain Current (note 1) | I_D | 0.75 | A |
| Pulsed Drain Current ($t_p=10\mu\text{s}$) | I_{DM} | 1.8 | A |
| Power Dissipation (note 1) | P_D | 350 | mW |
| Thermal Resistance from Junction to Ambient (note 1) | $R_{\theta JA}$ | 357 | $^\circ\text{C/W}$ |
| Junction Temperature | T_J | 150 | $^\circ\text{C}$ |
| Storage Temperature | T_{STG} | -55~+150 | $^\circ\text{C}$ |
| Lead Temperature for Soldering Purposes(1/8" duration for 10 s) | T_L | 260 | $^\circ\text{C}$ |

MOSFET ELECTRICAL CHARACTERISTICS

$T_a=25^\circ\text{C}$ unless otherwise specified

| Parameter | Symbol | Test Condition | Min | Typ | Max | Unit |
|---|---------------|---|------|------|----------|-----------|
| STATIC CHARACTERISTICS | | | | | | |
| Drain-source breakdown voltage | $V_{(BR)DSS}$ | $V_{GS} = 0V, I_D = 250\mu A$ | 20 | | | V |
| Zero gate voltage drain current | I_{DSS} | $V_{DS} = 20V, V_{GS} = 0V$ | | | 1 | μA |
| Gate-body leakage current | I_{GSS} | $V_{GS} = \pm 10V, V_{DS} = 0V$ | | | ± 20 | μA |
| Gate threshold voltage (note 2) | $V_{GS(th)}$ | $V_{DS} = V_{GS}, I_D = 250\mu A$ | 0.35 | 0.54 | 1.1 | V |
| Drain-source on-resistance (note 2) | $R_{DS(on)}$ | $V_{GS} = 4.5V, I_D = 0.65A$ | | 270 | 380 | $m\Omega$ |
| | | $V_{GS} = 2.5V, I_D = 0.55A$ | | 320 | 450 | $m\Omega$ |
| | | $V_{GS} = 1.8V, I_D = 0.45A$ | | 390 | 800 | $m\Omega$ |
| Forward transconductance (note 2) | g_{FS} | $V_{DS} = 10V, I_D = 0.8A$ | | 1.6 | | S |
| Diode forward voltage | V_{SD} | $I_S = 0.15A, V_{GS} = 0V$ | | | 1.2 | V |
| DYNAMIC CHARACTERISTICS (note 4) | | | | | | |
| Input capacitance | C_{iss} | $V_{DS} = 16V, V_{GS} = 0V, f = 1MHz$ | | 79 | 120 | pF |
| Output capacitance | C_{oss} | | | 13 | 20 | pF |
| Reverse transfer capacitance | C_{rss} | | | 9 | 15 | pF |
| SWITCHING CHARACTERISTICS (note 4) | | | | | | |
| Turn-on delay time (note 3) | $t_{d(on)}$ | $V_{GS} = 4.5V, V_{DS} = 10V,$ $I_D = 500mA, R_{GEN} = 10\Omega$ | | 6.7 | | ns |
| Turn-on rise time (note 3) | t_r | | | 4.8 | | ns |
| Turn-off delay time (note 3) | $t_{d(off)}$ | | | 17.3 | | ns |
| Turn-off fall time (note 3) | t_f | | | 7.4 | | ns |

Notes :

1. Surface mounted on FR4 board using the minimum recommended pad size.
2. Pulse Test : Pulse Width=300 μs , Duty Cycle=2%.
3. Switching characteristics are independent of operating junction temperatures.
4. Guaranteed by design, not subject to producing.

Typical Characteristics

Output Characteristics

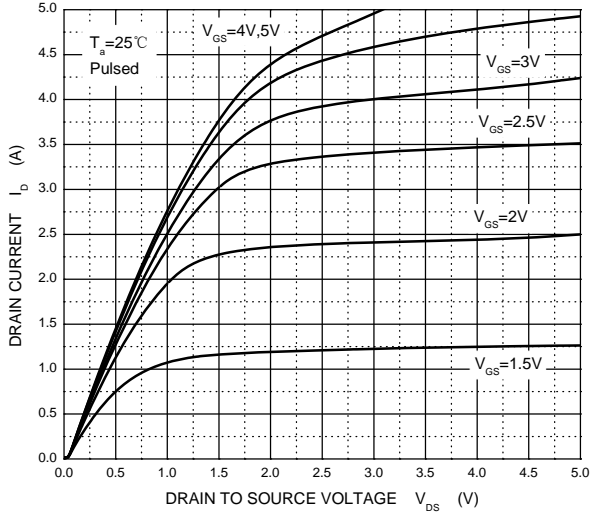

Transfer Characteristics

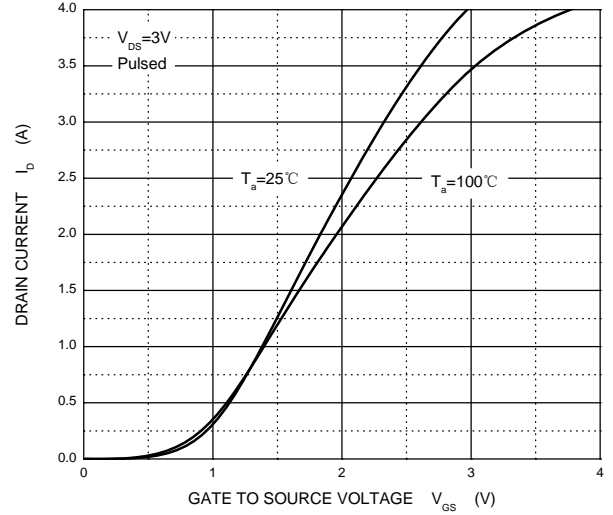

$R_{DS(ON)}$ — I_D

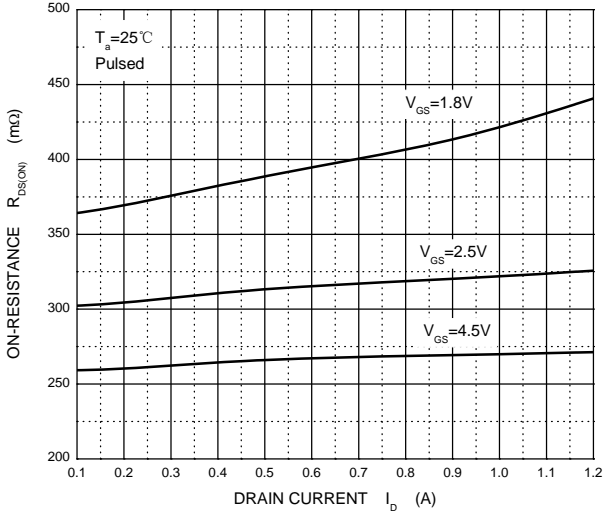

$R_{DS(ON)}$ — V_{GS}

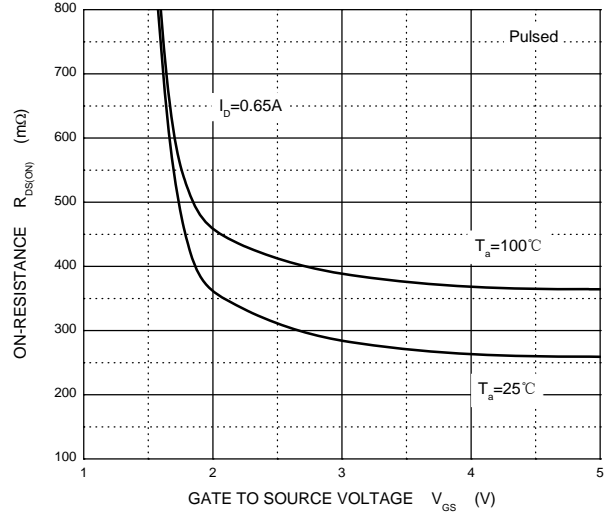

I_S — V_{SD}

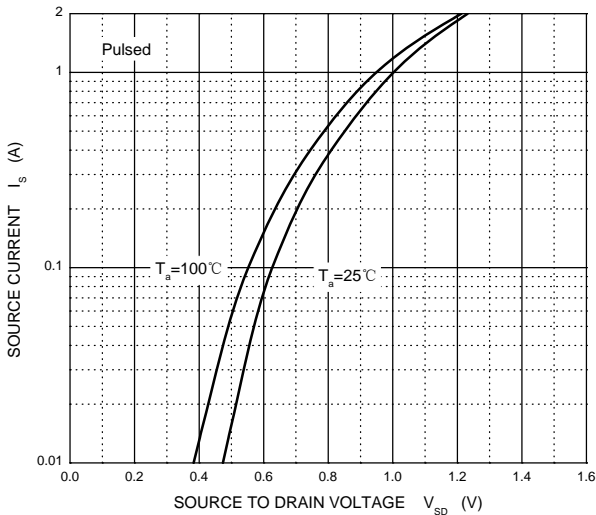

Threshold Voltage

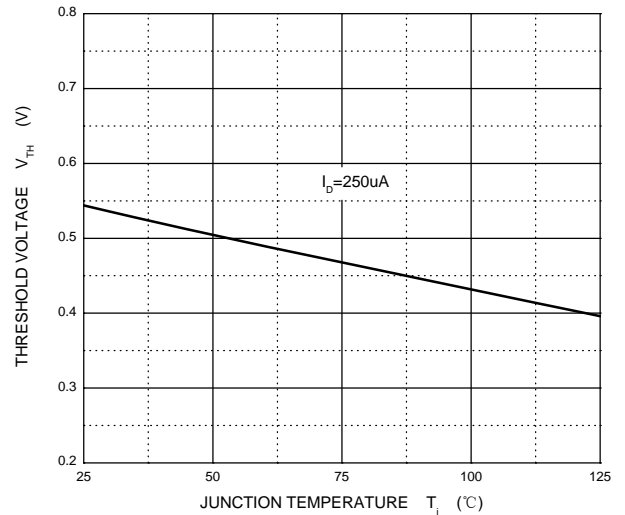

SOT-23 Package Outline Dimensions



| Symbol | Dimensions In Millimeters | | Dimensions In Inches | |
|--------|---------------------------|-------|----------------------|-------|
| | Min | Max | Min | Max |
| A | 0.900 | 1.150 | 0.035 | 0.045 |
| A1 | 0.000 | 0.100 | 0.000 | 0.004 |
| A2 | 0.900 | 1.050 | 0.035 | 0.041 |
| b | 0.300 | 0.500 | 0.012 | 0.020 |
| c | 0.080 | 0.150 | 0.003 | 0.006 |
| D | 2.800 | 3.000 | 0.110 | 0.118 |
| E | 1.200 | 1.400 | 0.047 | 0.055 |
| E1 | 2.250 | 2.550 | 0.089 | 0.100 |
| e | 0.950 TYP | | 0.037 TYP | |
| e1 | 1.800 | 2.000 | 0.071 | 0.079 |
| L | 0.550 REF | | 0.022 REF | |
| L1 | 0.300 | 0.500 | 0.012 | 0.020 |
| θ | 0° | 8° | 0° | 8° |

SOT-23 Suggested Pad Layout



Note:

1. Controlling dimension: in millimeters.
2. General tolerance: $\pm 0.05\text{mm}$.
3. The pad layout is for reference purposes only.

NOTICE

JCET reserve the right to make modifications, enhancements, improvements, corrections or other changes without further notice to any product herein. JCET does not assume any liability arising out of the application or use of any product described herein.

SOT-23 Tape and reel

SOT-23 Embossed Carrier Tape

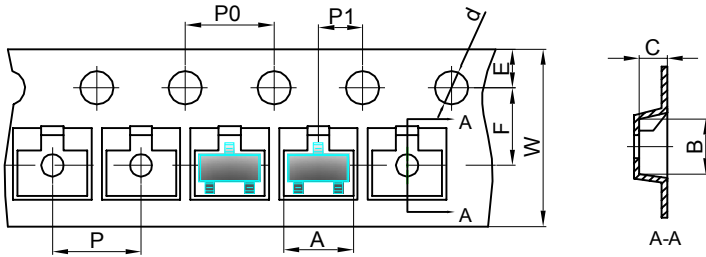

Packaging Description:

SOT-23 parts are shipped in tape. The carrier tape is made from a dissipative (carbon filled) polycarbonate resin. The cover tape is a multilayer film (Heat Activated Adhesive in nature) primarily composed of polyester film, adhesive layer, sealant, and anti-static sprayed agent. These reeled parts in standard option are shipped with 3,000 units per 7" or 17.8cm diameter reel. The reels are clear in color and is made of polystyrene plastic (anti-static coated).

| Dimensions are in millimeter | | | | | | | | | | |
|------------------------------|------|------|------|-------|------|------|------|------|------|------|
| Pkg type | A | B | C | d | E | F | P0 | P | P1 | W |
| SOT-23 | 3.15 | 2.77 | 1.22 | Ø1.50 | 1.75 | 3.50 | 4.00 | 4.00 | 2.00 | 8.00 |

SOT-23 Tape Leader and Trailer

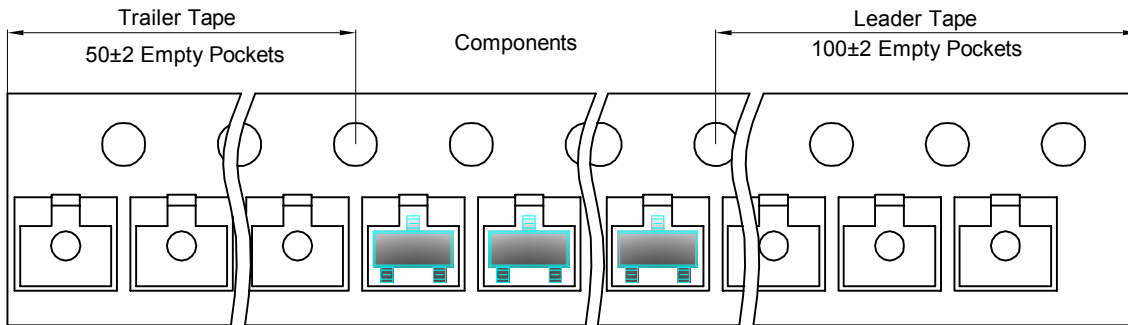

SOT-23 Reel

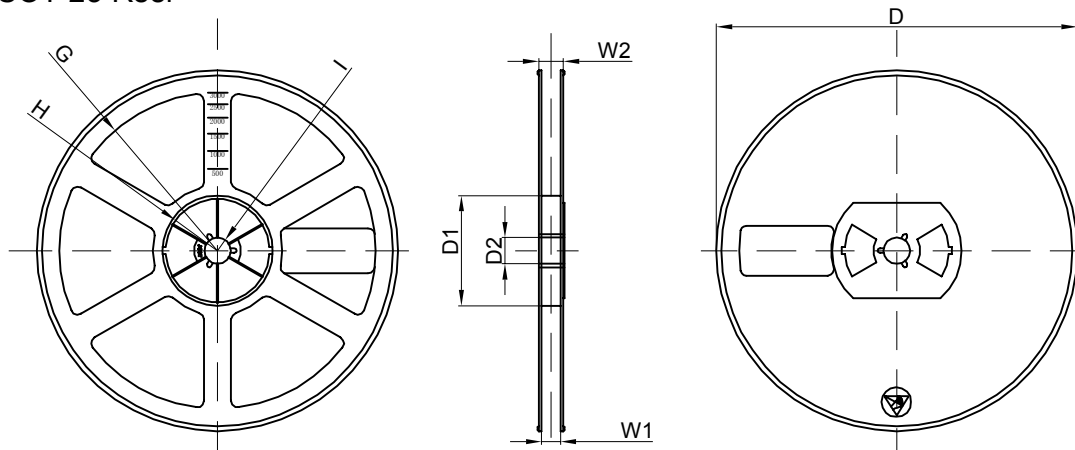

| Dimensions are in millimeter | | | | | | | | |
|------------------------------|---------|-------|-------|--------|--------|-------|------|-------|
| Reel Option | D | D1 | D2 | G | H | I | W1 | W2 |
| 7" Dia | Ø178.00 | 54.40 | 13.00 | R78.00 | R25.60 | R6.50 | 9.50 | 12.30 |

| REEL | Reel Size | Box | Box Size(mm) | Carton | Carton Size(mm) | G.W.(kg) |
|----------|-----------|------------|--------------|-------------|-----------------|----------|
| 3000 pcs | 7 inch | 30,000 pcs | 203×203×195 | 120,000 pcs | 438×438×220 | |