

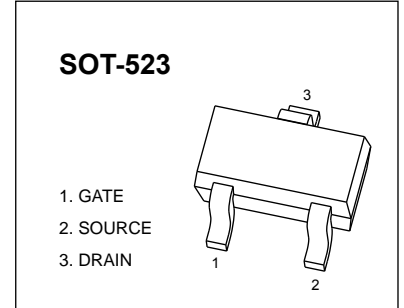

SOT-523 Plastic-Encapsulate MOSFETS

CJ1012 N-Channel Power MOSFET

$V_{(BR)DSS}$	$R_{DS(on)MAX}$	I_D
20 V	700mΩ@4.5V	500mA
	850mΩ@2.5V	



General Description

This Single N-Channel MOSFET has been designed using advanced Power Trench process to optimize the $R_{DS(ON)}$.

FEATURE

- High-Side Switching
- Low On-Resistance
- Low Threshold
- Fast Switching Speed
- ESD protected

APPLICATIONS

- Drivers: Relays, Solenoids, Lamps, Hammers, Displays, Memories
- Battery Operated Systems
- Power Supply Converter Circuits
- Load/Power Switching Cell Phones, Pagers

MARKING

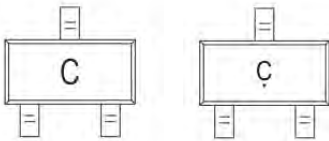

C=Device Code

Solid dot = Green molding compound device, if none, the normal device.

Equivalent Circuit

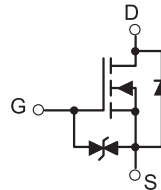

Maximum ratings ($T_a=25^\circ\text{C}$ unless otherwise noted)

Parameter	Symbol	Value	Unit
Drain-Source voltage	V_{DSS}	20	V
Gate-Source Voltage	V_{GS}	± 12	
Drain Current-Continuous	$I_{D(DC)}$	500	mA
Drain Current -Pulsed(note1)	$I_{DM(pulse)}$	1000	
Power Dissipation (note 2 , $T_a=25^\circ\text{C}$)	P_D	150	mW
Maximum Power Dissipation (note 3 , $T_c=25^\circ\text{C}$)		275	
Thermal Resistance from Junction to Ambient	$R_{\theta JA}$	833	$^\circ\text{C/W}$
Thermal Resistance from Junction to Case	$R_{\theta JC}$	455	
Storage Temperature	T_j	150	$^\circ\text{C}$
Junction Temperature	T_{stg}	-55 ~+150	

MOSFET ELECTRICAL CHARACTERISTICS

$T_a=25^\circ\text{C}$ unless otherwise specified

Parameter	Symbol	Test Condition	Min	Typ	Max	Unit
On/Off States						
Drain-Source Breakdown Voltage	$V_{(BR)DSS}$	$V_{GS} = 0V, I_D = 250\mu A$	20			V
Gate-Threshold Voltage	$V_{GS(th)}$	$V_{DS} = V_{GS}, I_D = 250\mu A$	0.45	0.8	1.2	
Gate-Body Leakage Current	I_{GSS}	$V_{DS} = 0V, V_{GS} = \pm 4.5V$			± 1	μA
Zero Gate Voltage Drain Current	I_{DSS}	$V_{DS} = 16V, V_{GS} = 0V$			100	nA
Drain-Source On-State Resistance	$R_{DS(on)}$	$V_{GS} = 4.5V, I_D = 600mA$		250	700	m Ω
		$V_{GS} = 2.5V, I_D = 500mA$		330	850	
Forward Transconductance	g_{FS}	$V_{DS} = 10V, I_D = 400mA$		1		S
Dynamic Characteristics						
Input Capacitance (note 4)	C_{iss}	$V_{DS} = 16V, V_{GS} = 0V, f = 1MHz$		100		pF
Output Capacitance (note 4)	C_{oss}			16		
Reverse Transfer Capacitance (note 4)	C_{rss}			12		
Total Gate Charge	Q_g	$V_{DS} = 10V, V_{GS} = 4.5V,$ $I_D = 250mA$		750		nC
Gate-Source Charge	Q_{gs}			75		
Gate-Drain Charge	Q_{gd}			225		
Switching Times (note 4)						
Turn-On Delay Time	$t_{d(on)}$	$V_{DD} = 10V,$ $R_L = 47\Omega, I_D = 200mA,$ $V_{GS} = 4.5V, R_G = 10\Omega$		5		nS
Rise Time	t_r			5		
Turn-Off Delay Time	$t_{d(off)}$			25		
Fall Time	t_f			11		
Drain-Source Diode Characteristics						
Drain-Source Diode Forward Voltage (note 5)	V_{SD}	$I_S = 0.15A, V_{GS} = 0V$			1.2	V

Notes:

1. Repetitive Rating: Pulse width limited by maximum junction temperature.
2. This test is performed with no heat sink at $T_a=25^\circ\text{C}$.
3. This test is performed with infinite heat sink at $T_c=25^\circ\text{C}$.
4. These parameters have no way to verify.
5. Pulse Test : Pulse Width $\leq 300\mu s$, Duty Cycle $\leq 0.5\%$.

Typical Characteristics

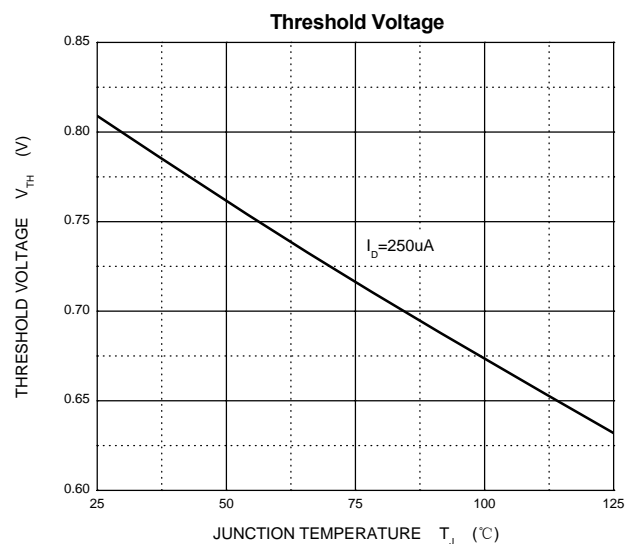
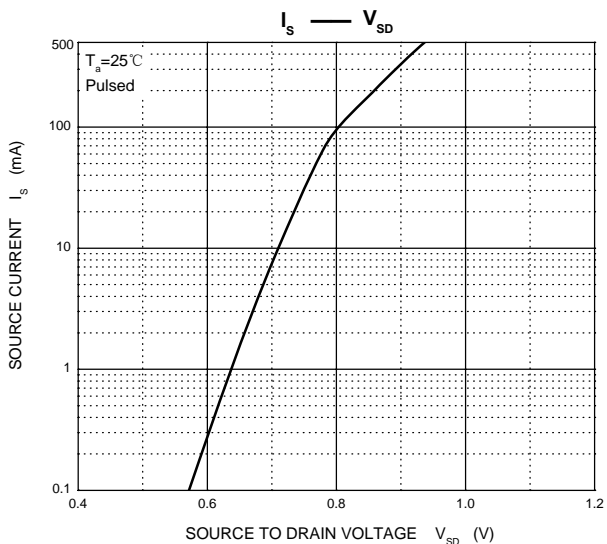
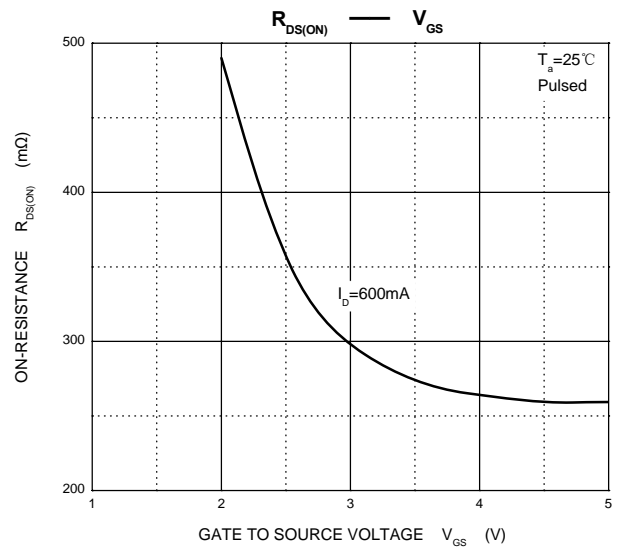
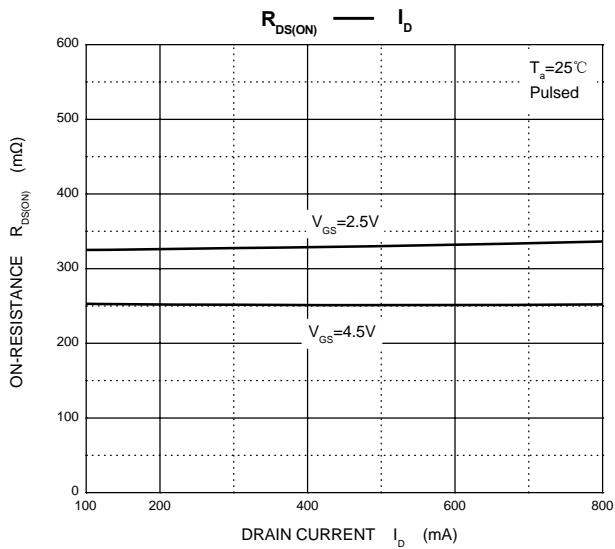
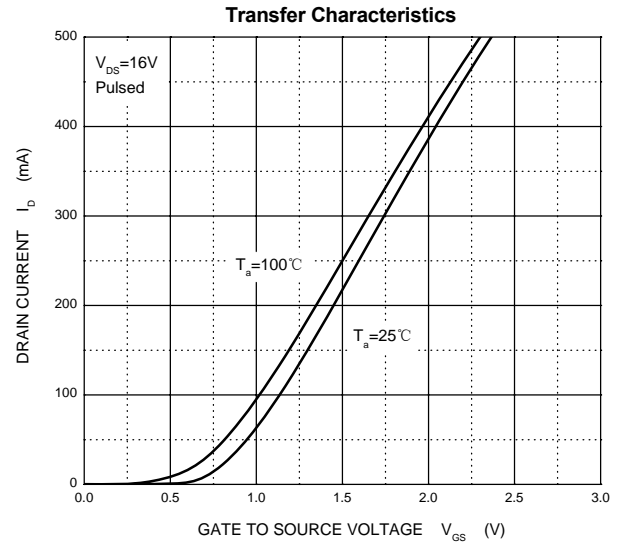
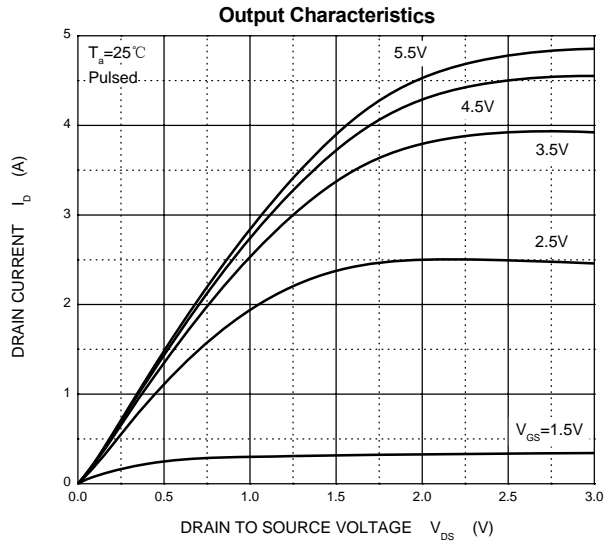

SOT-523 Package Outline Dimensions

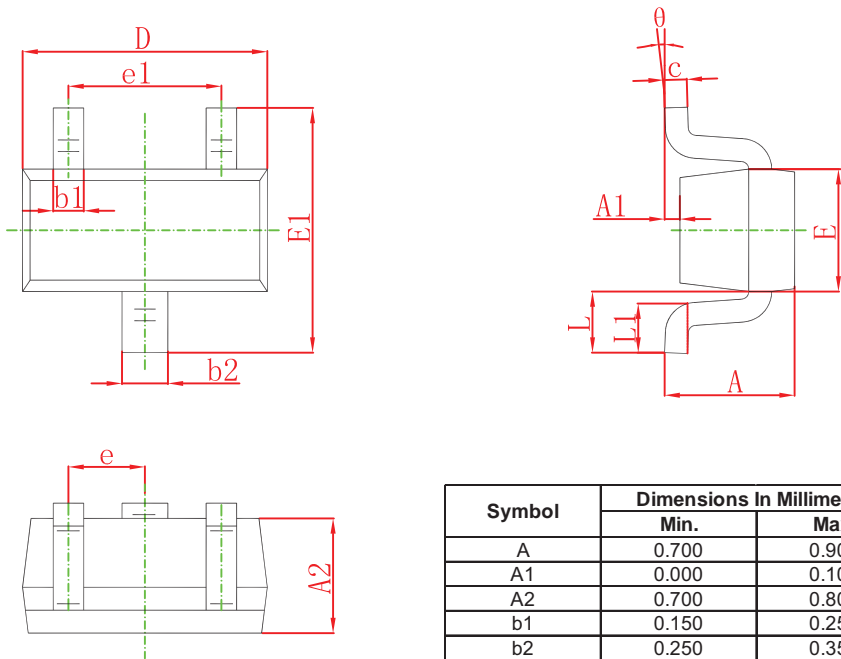

Symbol	Dimensions In Millimeters		Dimensions In Inches	
	Min.	Max.	Min.	Max.
A	0.700	0.900	0.028	0.035
A1	0.000	0.100	0.000	0.004
A2	0.700	0.800	0.028	0.031
b1	0.150	0.250	0.006	0.010
b2	0.250	0.350	0.010	0.014
c	0.100	0.200	0.004	0.008
D	1.500	1.700	0.059	0.067
E	0.700	0.900	0.028	0.035
E1	1.450	1.750	0.057	0.069
e	0.500 TYP.		0.020 TYP.	
e1	0.900	1.100	0.035	0.043
L	0.400 REF.		0.016 REF.	
L1	0.260	0.460	0.010	0.018
θ	0°	8°	0°	8°

SOT-523 Suggested Pad Layout

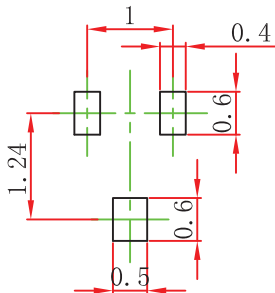

- Note:
1. Controlling dimension: in millimeters.
 2. General tolerance: ± 0.05 mm.
 3. The pad layout is for reference purposes only.

NOTICE

JCET reserve the right to make modifications, enhancements, improvements, corrections or other changes without further notice to any product herein. JCET does not assume any liability arising out of the application or use of any product described herein.

SOT-523 Tape and reel

SOT-523 Embossed Carrier Tape

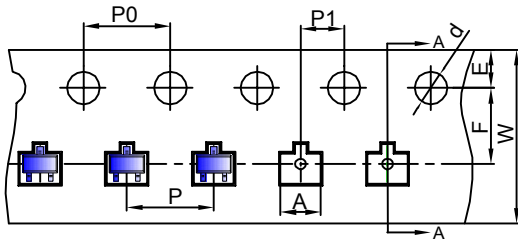

Packaging Description:

SOT-523 parts are shipped in tape. The carrier tape is made from a dissipative (carbon filled) polycarbonate resin. The cover tape is a multilayer film (Heat Activated Adhesive in nature) primarily composed of polyester film, adhesive layer, sealant, and anti-static sprayed agent. These reeled parts in standard option are shipped with 3,000 units per 7" or 17.8cm diameter reel. The reels are clear in color and is made of polystyrene plastic (anti-static coated).

Dimensions are in millimeter											
Pkg type	A	B	C	d	E	F	P0	P	P1	W	
SOT-523	1.85	1.85	0.875	Ø1.50	1.75	3.50	4.00	4.00	2.00	8.00	

SOT-523 Tape Leader and Trailer

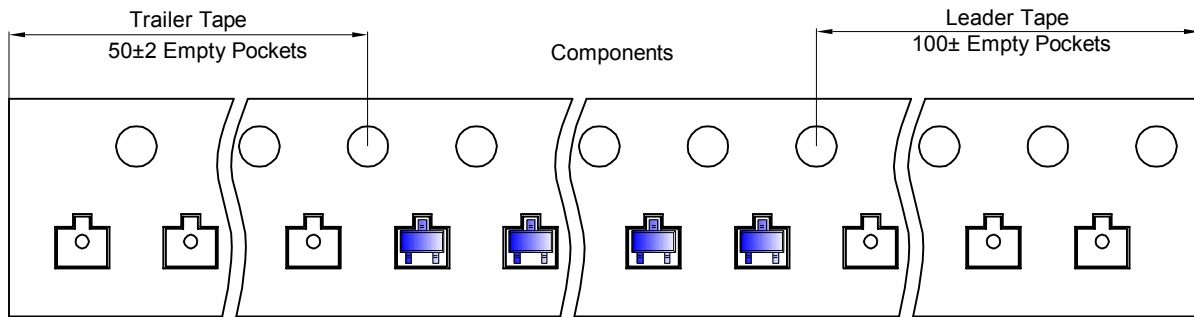

SOT-523 Reel

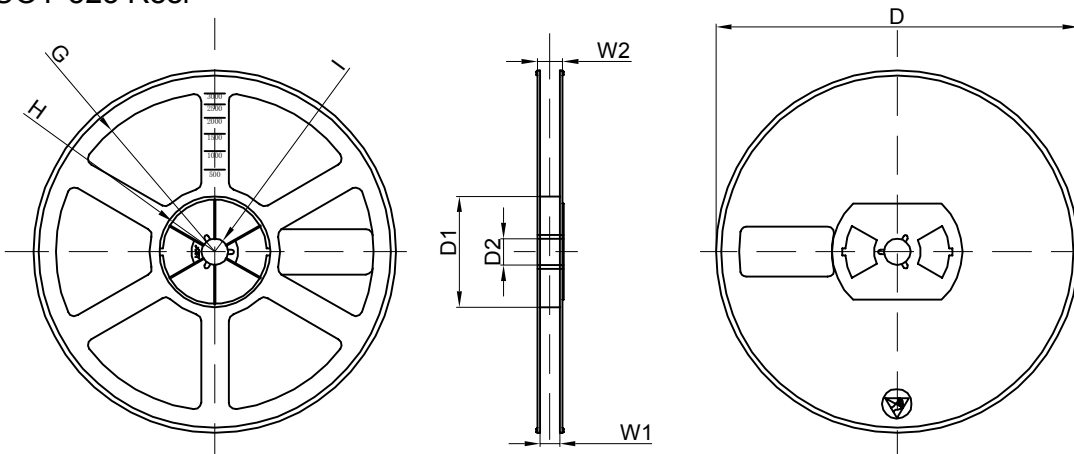

Dimensions are in millimeter								
Reel Option	D	D1	D2	G	H	I	W1	W2
7" Dia	Ø178.00	54.40	13.00	R78.00	R25.60	R6.50	9.50	12.30

REEL	Reel Size	Box	Box Size(mm)	Carton	Carton Size(mm)	G.W.(kg)
3000 pcs	7 inch	30,000 pcs	203×203×195	120,000 pcs	438×438×220	