

7806

3-terminal 1 A positive voltage regulator

Features

- Output Current up to 1 A
- Thermal Overload Protection
- Short Circuit Protection
- Output Transistor Safe Operating Area Protection

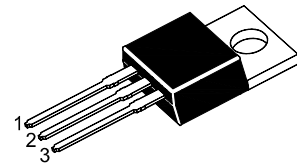

1.Input 2.Common 3.Output

TO-220 Plastic Package

Absolute Maximum Ratings ($T_a = 25\text{ }^\circ\text{C}$)

Parameter	Symbol	Value	Units
Input Voltage	V_I	35	V
Thermal Resistance Junction-Cases	$R_{\theta JC}$	5	$^\circ\text{C/W}$
Thermal Resistance Junction-Air	$R_{\theta JA}$	65	$^\circ\text{C/W}$
Operating Temperature Range	T_{Opr}	0 to + 125	$^\circ\text{C}$
Storage Temperature Range	T_{stg}	- 65 to + 150	$^\circ\text{C}$

Electrical Characteristics

($0\text{ }^\circ\text{C} < T_J < 125\text{ }^\circ\text{C}$, $I_O = 500\text{ mA}$, $V_I = 11\text{ V}$, $C_I = 0.33\text{ }\mu\text{F}$, $C_O = 0.1\text{ }\mu\text{F}$, unless otherwise specified)

Parameter	Symbol	Conditions	Min.	Typ.	Max.	Unit
Output Voltage	V_O	$T_J = + 25\text{ }^\circ\text{C}$	5.75	6	6.25	V
		$5\text{ mA} \leq I_O \leq 1\text{ A}$, $P_O \leq 15\text{ W}$ $V_I = 8\text{ V to } 21\text{ V}$	5.7	6	6.3	
Line Regulation ¹⁾	Regline	$T_J = + 25\text{ }^\circ\text{C}$	-	-	120	mV
		$V_I = 8\text{ V to } 25\text{ V}$ $V_I = 9\text{ V to } 13\text{ V}$	-	-	60	
Load Regulation ¹⁾	Regload	$T_J = + 25\text{ }^\circ\text{C}$	-	-	120	mV
		$I_O = 5\text{ mA to } 1.5\text{ A}$ $I_O = 250\text{ mA to } 750\text{ mA}$	-	-	60	
Quiescent Current	I_Q	$T_J = + 25\text{ }^\circ\text{C}$	-	-	8	mA
Quiescent Current Change	ΔI_Q	$I_O = 5\text{ mA to } 1\text{ A}$	-	-	0.5	mA
		$V_I = 8\text{ V to } 25\text{ V}$	-	-	1.3	
Output Voltage Drift	$\Delta V_O / \Delta T$	$I_O = 5\text{ mA}$	-	-0.8	-	$\text{mV}/^\circ\text{C}$
Output Noise Voltage	V_N	$f = 10\text{ Hz to } 100\text{ KHz}$, $T_A = + 25\text{ }^\circ\text{C}$	-	45	-	μV
Ripple Rejection	RR	$f = 120\text{ Hz}$, $V_O = 9\text{ V to } 19\text{ V}$	59	-	-	dB
Dropout Voltage	V_{Drop}	$I_O = 1\text{ A}$, $T_J = + 25\text{ }^\circ\text{C}$	-	2	-	V
Output Resistance	R_O	$f = 1\text{ KHz}$	-	19	-	$\text{m}\Omega$
Short Circuit Current	I_{SC}	$V_I = 35\text{ V}$, $T_A = + 25\text{ }^\circ\text{C}$	-	250	-	mA
Peak Current	I_{PK}	$T_J = + 25\text{ }^\circ\text{C}$	-	2.2	-	A

¹⁾ Load and line regulation are specified at constant junction temperature. Changes in V_O due to heating effects must be taken into account separately. Pulse testing with low duty is used.

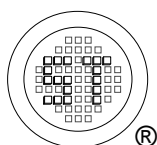

SEMTECH ELECTRONICS LTD.



Typical Performance Characteristics

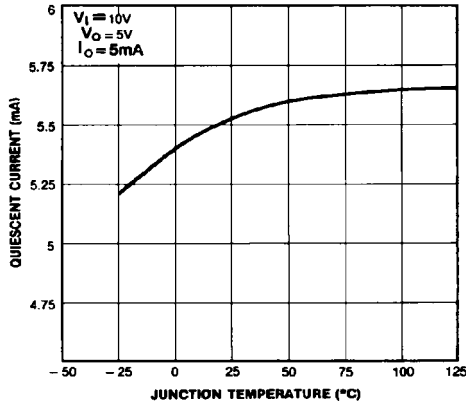

Figure 1. Quiescent Current

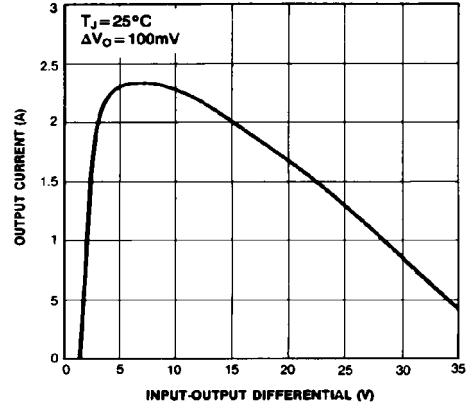

Figure 2. Peak Output Current

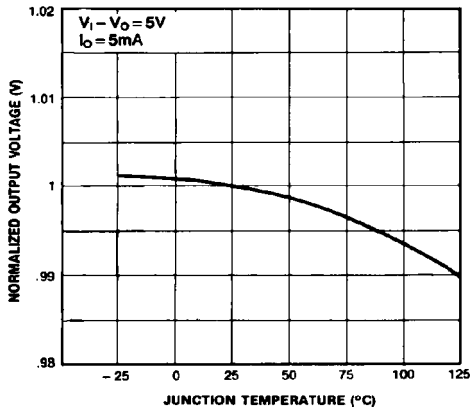

Figure 3. Output Voltage

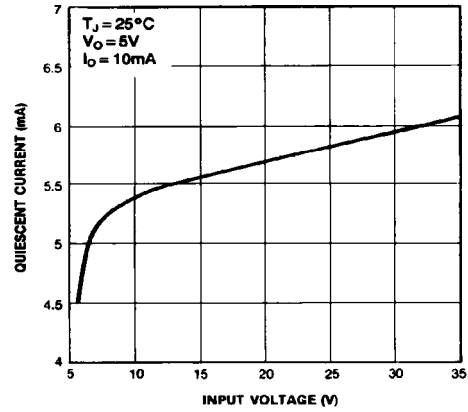
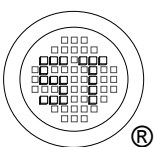

Figure 4. Quiescent Current



SEMTECH ELECTRONICS LTD.



TO-220 PACKAGE OUTLINE

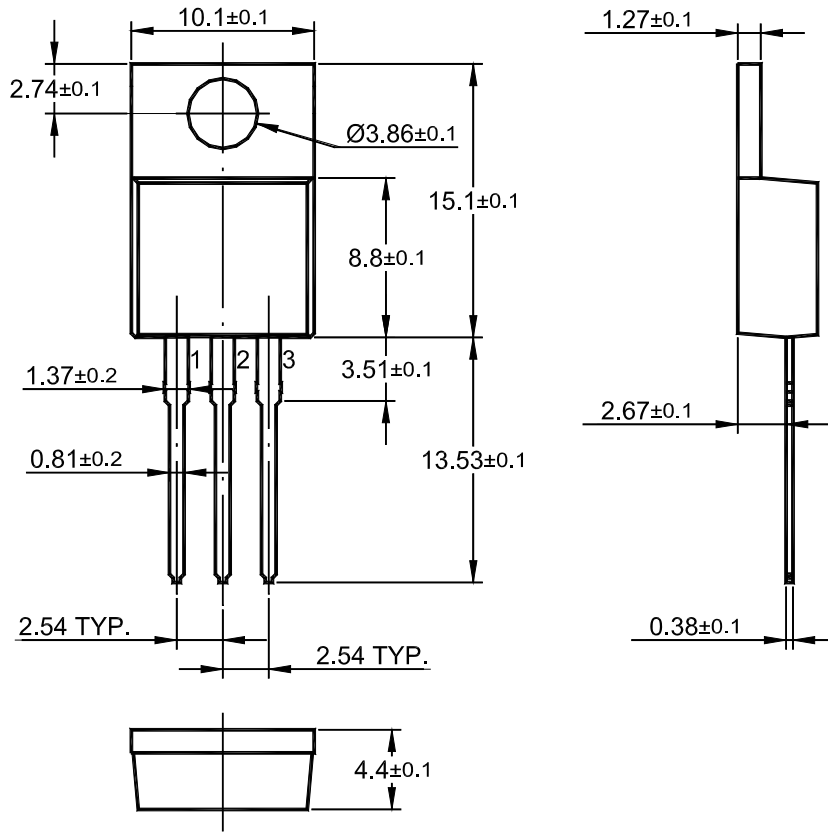

Dimensions in mm

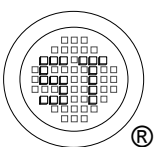

SEMTECH ELECTRONICS LTD.

