

## SOT-323 Plastic-Encapsulate MOSFETS

### 2SK3018 N-channel MOSFET

$V_{(BR)DSS}$	$R_{DS(on)MAX}$	$I_D$
30V	8Ω@4V	100mA
	13Ω@2.5V	

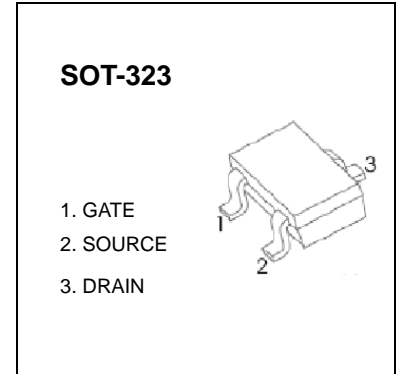

#### FEATURE

- Low on-resistance
- Fast switching speed
- Low voltage drive makes this device ideal for Portable equipment
- Easily designed drive circuits
- Easy to parallel

#### APPLICATION

- Interfacing , Switching

#### MARKING

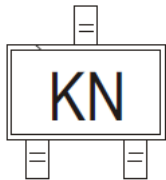

#### Equivalent Circuit

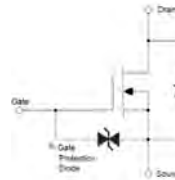

#### MOSFET MAXIMUM RATINGS ( $T_a = 25^\circ\text{C}$ unless otherwise noted)

Symbol	Parameter	Value	Unit
$V_{DS}$	Drain-Source voltage	30	V
$V_{GS}$	Gate-Source Voltage	±20	V
$I_D$	Continuous Drain Current	0.1	A
$P_D$	Power Dissipation	0.2	W
$T_J$	Junction Temperature	150	°C
$T_{stg}$	Storage Temperature	-55-150	°C
$R_{\theta JA}$	Thermal Resistance from Junction to Ambient	625	°C /W

## MOSFET ELECTRICAL CHARACTERISTICS

$T_a=25\text{ }^\circ\text{C}$  unless otherwise specified

Parameter	Symbol	Test Condition	Min	Typ	Max	Units
<b>Off Characteristics</b>						
Drain-Source Breakdown Voltage	$V_{(BR)DSS}$	$V_{GS} = 0V, I_D = 10\mu A$	30			V
Zero Gate Voltage Drain Current	$I_{DSS}$	$V_{DS} = 30V, V_{GS} = 0V$			0.2	$\mu A$
Gate –Source leakage current	$I_{GSS}$	$V_{GS} = \pm 20V, V_{DS} = 0V$			$\pm 2$	$\mu A$
Gate Threshold Voltage	$V_{GS(th)}$	$V_{DS} = 3V, I_D = 100\mu A$	0.8		1.5	V
Drain-Source On-Resistance	$R_{DS(on)}$	$V_{GS} = 4V, I_D = 10mA$			8	$\Omega$
		$V_{GS} = 2.5V, I_D = 1mA$			13	$\Omega$
Forward Transconductance	$g_{FS}$	$V_{DS} = 3V, I_D = 10mA$	20			mS
<b>Dynamic Characteristics*</b>						
Input Capacitance	$C_{iss}$	$V_{DS} = 5V, V_{GS} = 0V, f = 1MHz$		13		pF
Output Capacitance	$C_{oss}$			9		pF
Reverse Transfer Capacitance	$C_{rss}$			4		pF
<b>Switching Characteristics*</b>						
Turn-On Delay Time	$t_{d(on)}$	$V_{GS} = 5V, V_{DD} = 5V,$ $I_D = 10mA, R_g = 10\Omega, R_L = 500\Omega$		15		ns
Rise Time	$t_r$			35		ns
Turn-Off Delay Time	$t_{d(off)}$			80		ns
Fall Time	$t_f$			80		ns

\*These parameters have no way to verify.

# Typical Characteristics

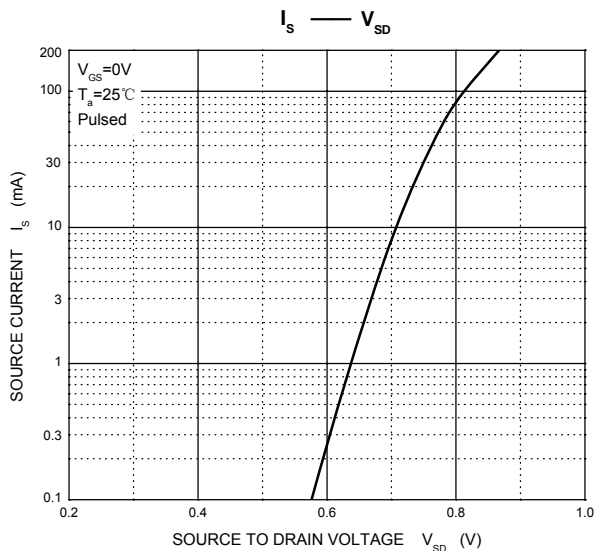
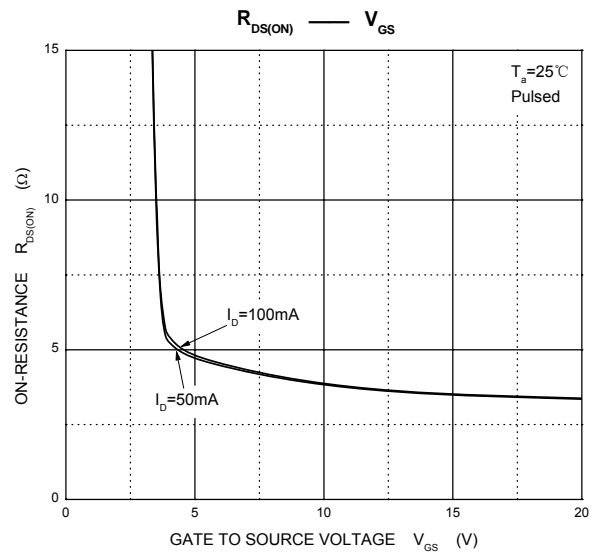
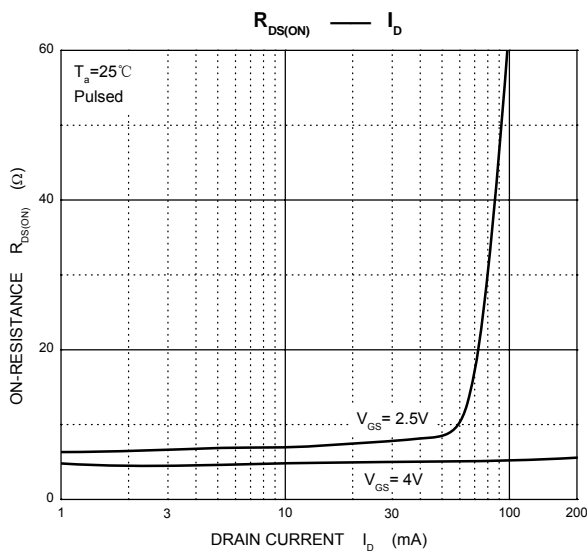
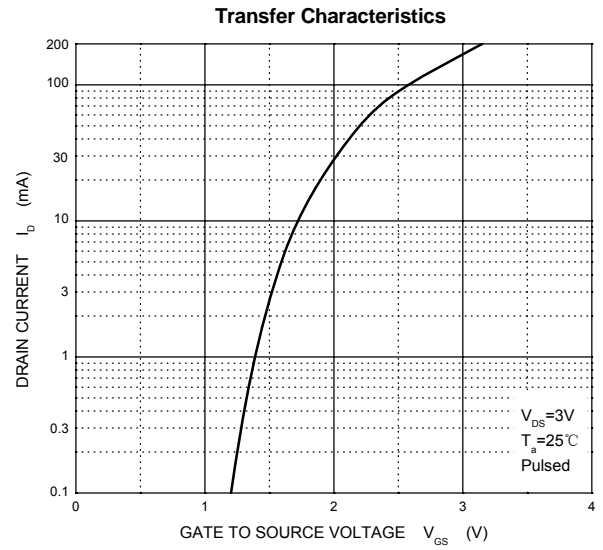
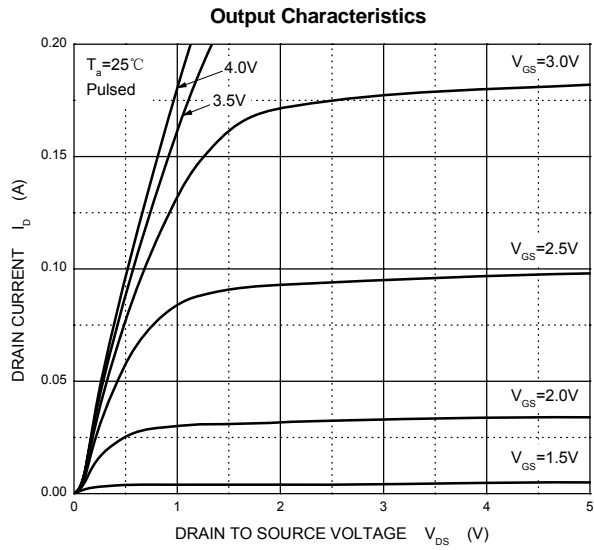

## SOT-323 Package Outline Dimensions

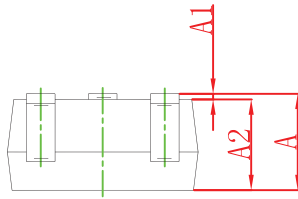
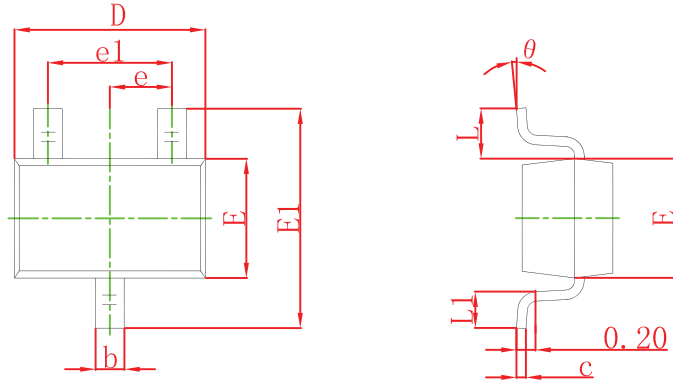

Symbol	Dimensions In Millimeters		Dimensions In Inches	
	Min	Max	Min	Max
A	0.900	1.100	0.035	0.043
A1	0.000	0.100	0.000	0.004
A2	0.900	1.000	0.035	0.039
b	0.200	0.400	0.008	0.016
c	0.080	0.150	0.003	0.006
D	2.000	2.200	0.079	0.087
E	1.150	1.350	0.045	0.053
E1	2.150	2.450	0.085	0.096
e	0.650 TYP		0.026 TYP	
e1	1.200	1.400	0.047	0.055
L	0.525 REF		0.021 REF	
L1	0.260	0.460	0.010	0.018
theta	0°	8°	0°	8°

## SOT-323 Suggested Pad Layout

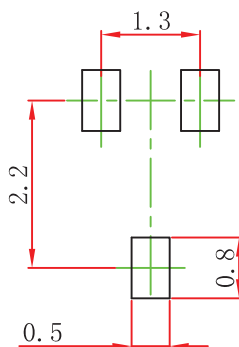

Note:

1. Controlling dimension: in millimeters.
2. General tolerance:  $\pm 0.05$  mm.
3. The pad layout is for reference purposes only.

### NOTICE

JCET reserve the right to make modifications, enhancements, improvements, corrections or other changes without further notice to any product herein. JCET does not assume any liability arising out of the application or use of any product described herein.

# SOT-323 Tape and reel

## SOT-323 Embossed Carrier Tape

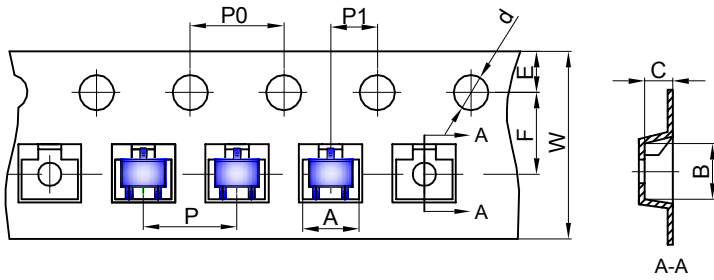

**Packaging Description:**  
 SOT-323 parts are shipped in tape. The carrier tape is made from a dissipative (carbon filled) polycarbonate resin. The cover tape is a multilayer film (Heat Activated Adhesive in nature) primarily composed of polyester film, adhesive layer, sealant, and anti-static sprayed agent. These reeled parts in standard option are shipped with 3,000 units per 7" or 17.8cm diameter reel. The reels are clear in color and is made of polystyrene plastic (anti-static coated).

Dimensions are in millimeter										
Pkg type	A	B	C	d	E	F	P0	P	P1	W
SOT-323	2.25	2.55	1.19	Ø1.55	1.75	3.50	4.00	4.00	2.00	8.00

## SOT-323 Tape Leader and Trailer

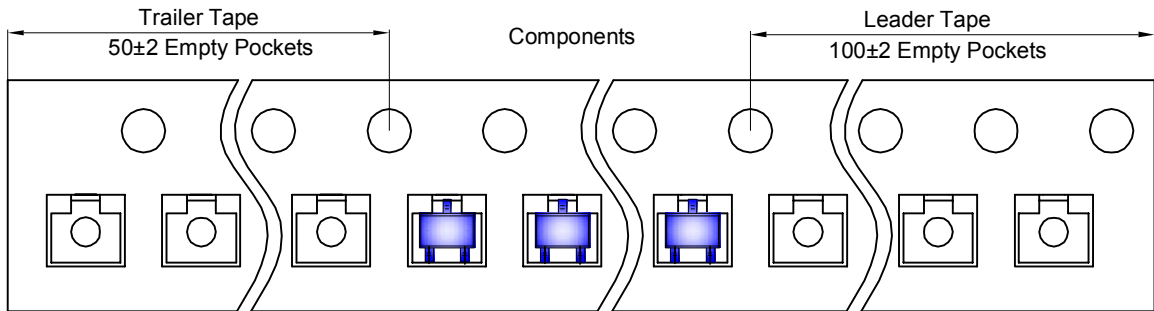

## SOT-323 Reel

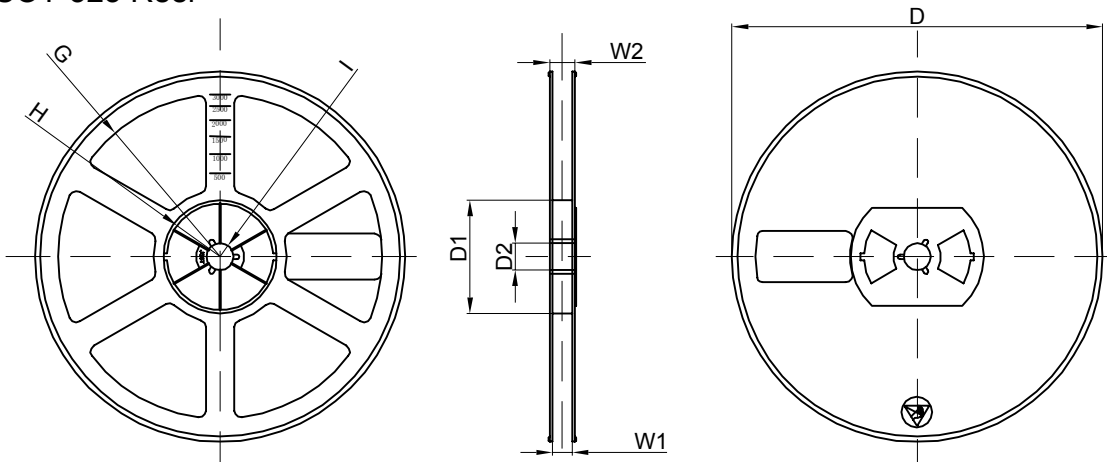

Dimensions are in millimeter								
Reel Option	D	D1	D2	G	H	I	W1	W2
7" Dia	Ø178.00	54.40	13.00	R78.00	R25.60	R6.50	9.50	12.30

REEL	Reel Size	Box	Box Size(mm)	Carton	Carton Size(mm)	G.W.(kg)
3000 pcs	7 inch	30,000 pcs	203×203×195	120,000 pcs	438×438×220	