

## TO-220F Plastic-Encapsulate Transistors

### 2SD2061 TRANSISTOR (NPN)

#### FEATURES

- Low Saturation Voltage
- Excellent DC Current Gain Characteristic

#### MAXIMUM RATINGS ( $T_a=25^{\circ}\text{C}$ unless otherwise noted)

Symbol	Parameter	Value	Unit
$V_{CBO}$	Collector-Base Voltage	80	V
$V_{CEO}$	Collector-Emitter Voltage	60	V
$V_{EBO}$	Emitter-Base Voltage	5	V
$I_C$	Collector Current -Continuous	3	A
$P_C$	Collector Power Dissipation	2	W
$T_j$	Junction Temperature	150	$^{\circ}\text{C}$
$T_{stg}$	Storage Temperature Range	-55-150	$^{\circ}\text{C}$

#### TO-220F

1. BASE
2. COLLECTOR
3. EMITTER

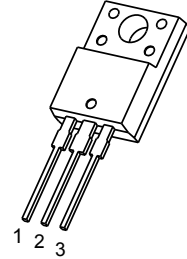

#### ELECTRICAL CHARACTERISTICS ( $T_a=25^{\circ}\text{C}$ unless otherwise specified)

Parameter	Symbol	Test conditions	Min	Typ	Max	Unit
Collector-base breakdown voltage	$V_{(BR)CBO}$	$I_C=50\mu\text{A}, I_E=0$	80			V
Collector-emitter breakdown voltage	$V_{(BR)CEO}$	$I_C=1\text{mA}, I_B=0$	60			V
Emitter-base breakdown voltage	$V_{(BR)EBO}$	$I_E=50\mu\text{A}, I_C=0$	5			V
Collector cut-off current	$I_{CBO}$	$V_{CB}=60\text{V}, I_E=0$			10	$\mu\text{A}$
Emitter cut-off current	$I_{EBO}$	$V_{EB}=4\text{V}, I_C=0$			10	$\mu\text{A}$
DC current gain	$h_{FE}$	$V_{CE}=5\text{V}, I_C=0.5\text{A}$	100		320	
Collector-emitter saturation voltage	$V_{CE(sat)}$	$I_C=2\text{A}, I_B=0.2\text{A}$			1	V
Base-emitter saturation voltage	$V_{BE(sat)}$	$I_C=2\text{A}, I_B=0.2\text{A}$			1.5	V
Transition frequency	$f_T$	$V_{CE}=5\text{V}, I_C=0.5\text{A}, f=5\text{MHz}$		8		MHz
Collector output capacitance	$C_{ob}$	$V_{CB}=10\text{V}, I_E=0, f=1\text{MHz}$		70		pF

# Typical Characteristics

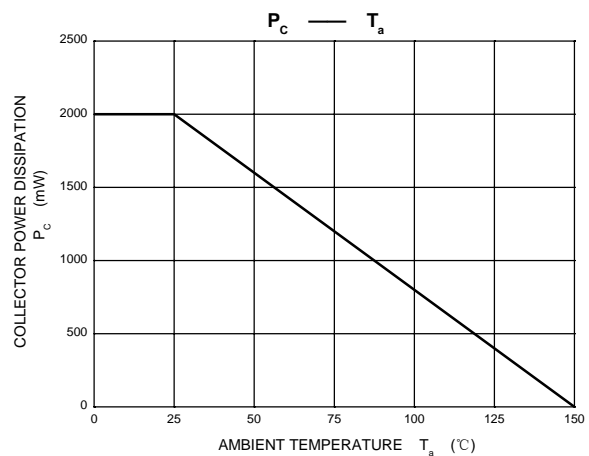
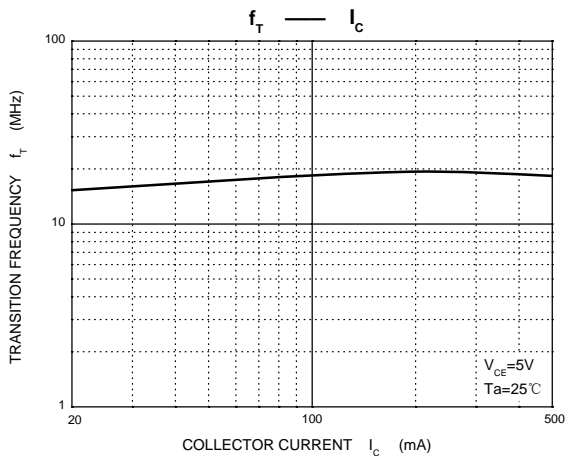
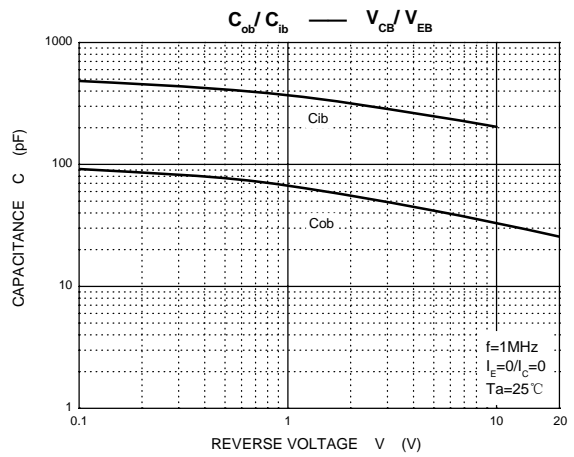
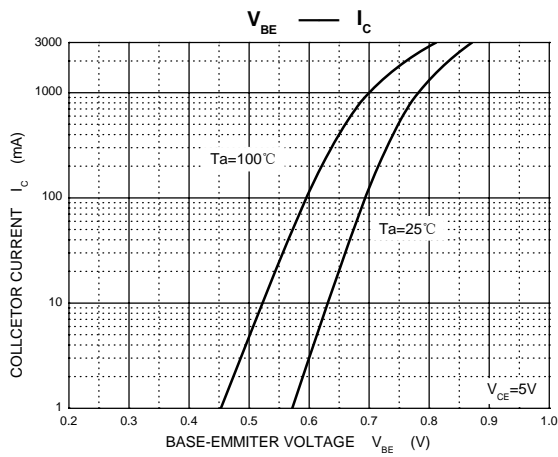
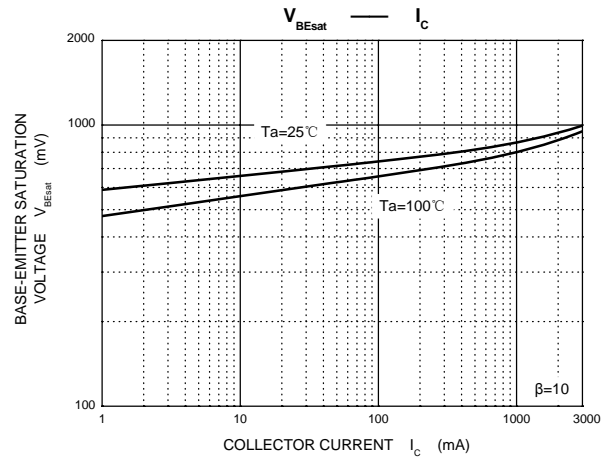
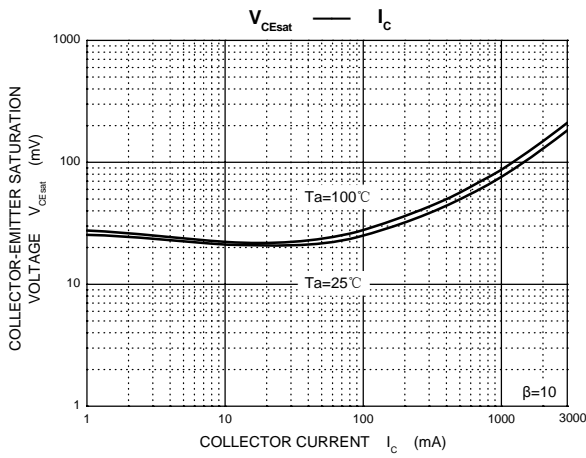
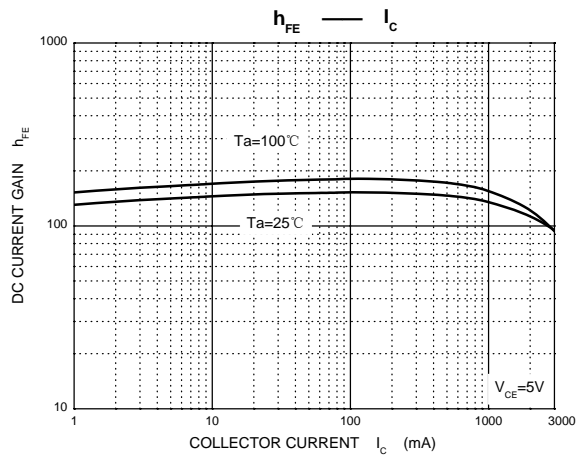
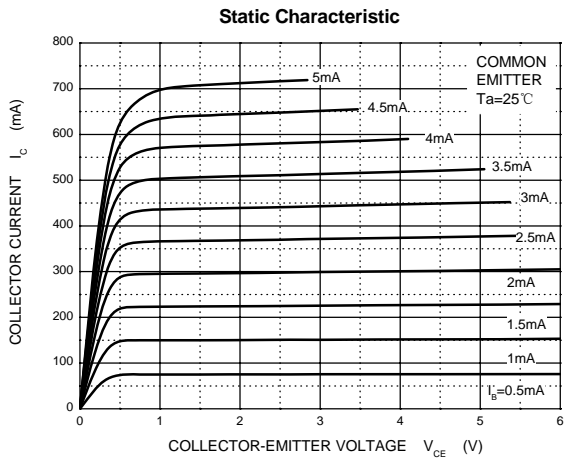

# TO-220F Package Outline Dimensions

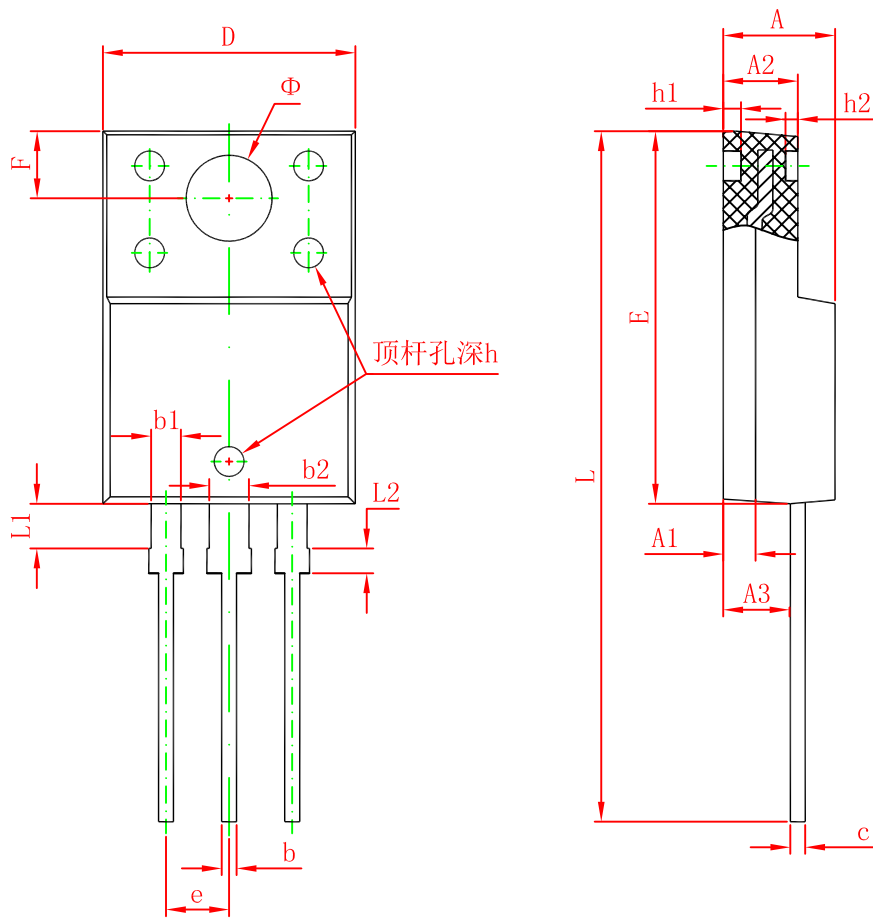

Symbol	Dimensions In Millimeters		Dimensions In Inches	
	Min.	Max.	Min.	Max.
A	4.300	4.700	0.169	0.185
A1	1.300 REF.		0.051 REF.	
A2	2.800	3.200	0.110	0.126
A3	2.500	2.900	0.098	0.114
b	0.500	0.750	0.020	0.030
b1	1.100	1.350	0.043	0.053
b2	1.500	1.750	0.059	0.069
c	0.500	0.750	0.020	0.030
D	9.960	10.360	0.392	0.408
E	14.800	15.200	0.583	0.598
e	2.540 TYP.		0.100 TYP.	
F	2.700 REF.		0.106 REF.	
Φ	3.500 REF.		0.138 REF.	
h	0.000	0.300	0.000	0.012
h1	0.800 REF.		0.031 REF.	
h2	0.500 REF.		0.020 REF.	
L	28.000	28.400	1.102	1.118
L1	1.700	1.900	0.067	0.075
L2	0.900	1.100	0.035	0.043