

TO-92L Plastic-Encapsulate Transistors

2SA1013 TRANSISTOR (PNP)

FEATURE

- High Voltage: $V_{CEO} = -160V$
- Large Continuous Collector Current Capability
- Complementary to 2SC2383

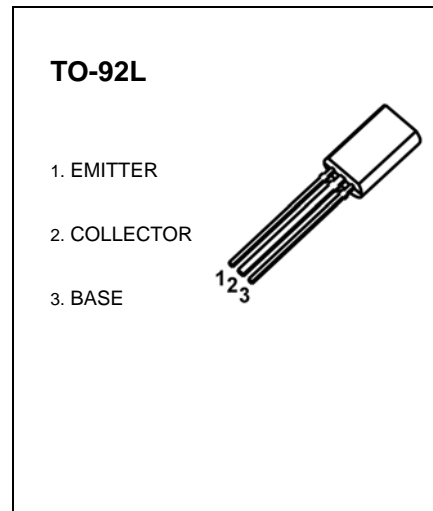

MARKING



A1013=Device code
Solid dot= Green molding compound device,
if none, the normal device
XXX=Code

Equivalent Circuit

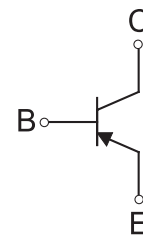

ORDERING INFORMATION

Part Number	Package	Packing Method	Pack Quantity
2SA1013	TO-92L	Bulk	500pcs/Bag
2SA1013-TA	TO-92L	Tape	2000pcs/Box

MAXIMUM RATINGS ($T_a = 25^\circ C$ unless otherwise noted)

Symbol	Parameter	Value	Unit
V_{CBO}	Collector-Base Voltage	-160	V
V_{CEO}	Collector-Emitter Voltage	-160	V
V_{EBO}	Emitter-Base Voltage	-6	V
I_C	Collector Current -Continuous	-1	A
P_C	Collector Power Dissipation	0.9	W
T_j	Junction Temperature	150	$^\circ C$
T_{stg}	Storage Temperature	-55 to +150	$^\circ C$

ELECTRICAL CHARACTERISTICS

$T_a=25^\circ\text{C}$ unless otherwise specified

Parameter	Symbol	Test conditions	Min	Max	Unit
Collector-base breakdown voltage	$V_{(BR)CBO}$	$I_C=-100\mu\text{A}$, $I_E=0$	-160		V
Collector-emitter breakdown voltage	$V_{(BR)CEO}$	$I_C=-1\text{mA}$, $I_B=0$	-160		V
Emitter-base breakdown voltage	$V_{(BR)EBO}$	$I_E=-10\mu\text{A}$, $I_C=0$	-6		V
Collector cut-off current	I_{CBO}	$V_{CB}=-150\text{V}$, $I_E=0$		-1	μA
Emitter cut-off current	I_{EBO}	$V_{EB}=-6\text{V}$, $I_C=0$		-1	μA
DC current gain	h_{FE}	$V_{CE}=-5\text{V}$, $I_C=-200\text{mA}$	60	320	
Collector-emitter saturation voltage	$V_{CE(sat)}$	$I_C=-500\text{mA}$, $I_B=-50\text{mA}$		-1.5	V
Base-emitter voltage	V_{BE}	$I_C=-5\text{mA}$, $V_{CE}=-5\text{V}$		-0.75	V
Transition frequency	f_T	$V_{CE}=-5\text{V}$, $I_C=-200\text{mA}$	15		MHz
Collector Output capacitance	C_{ob}	$V_{CB}=-10\text{V}$, $I_E=0$, $f=1\text{MHz}$		35	pF

CLASSIFICATION OF h_{FE}

Rank	R	O	Y
Range	60-120	100-200	160-320

Typical Characteristics

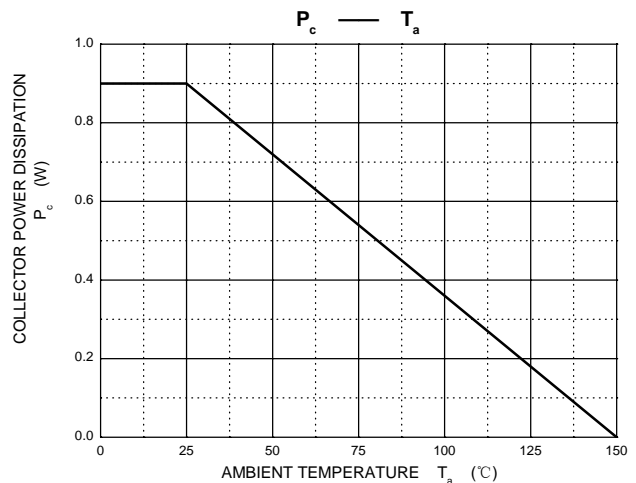
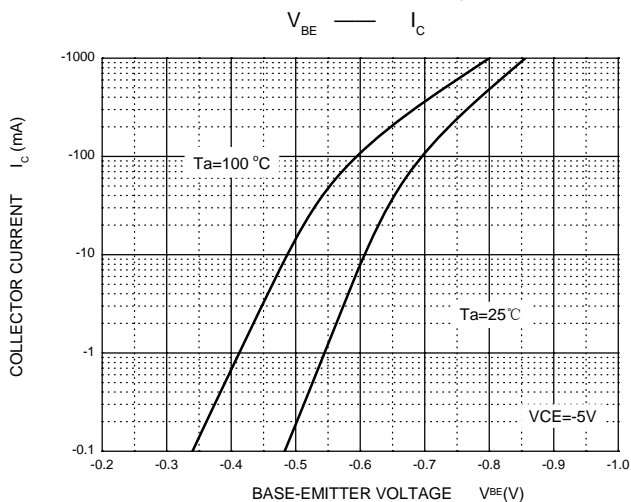
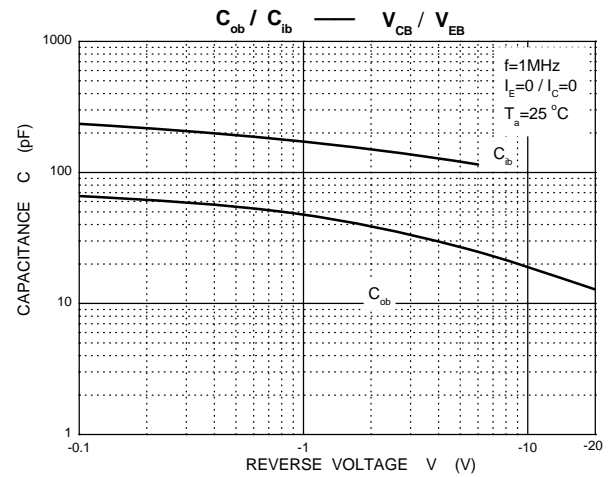
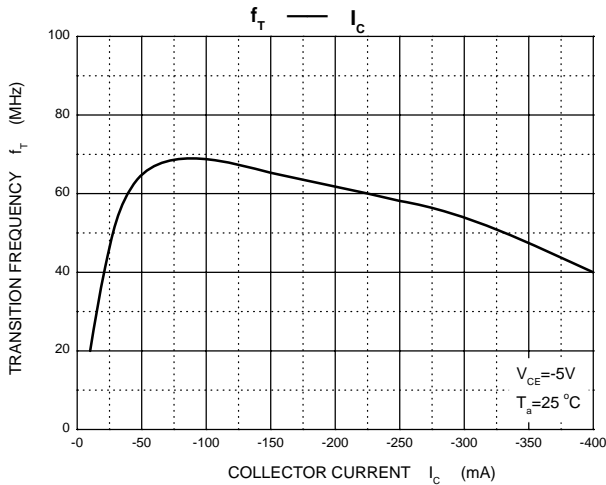
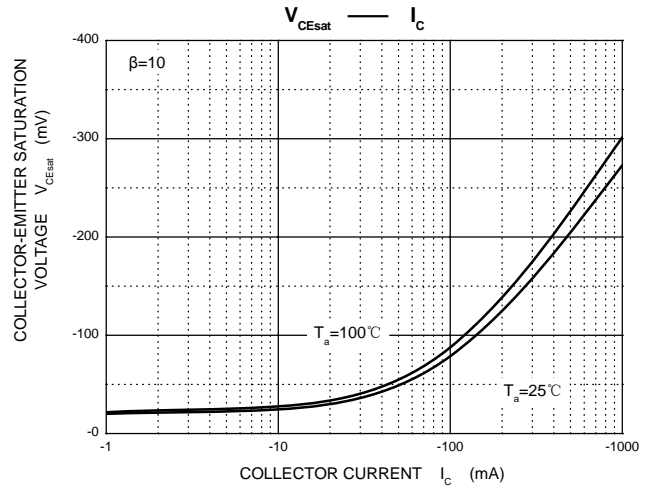
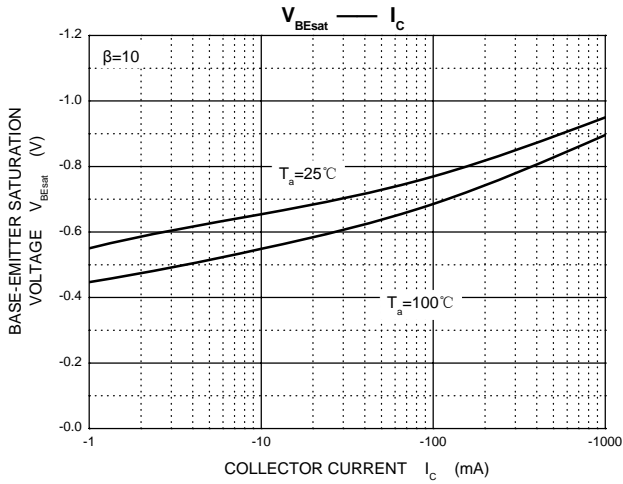
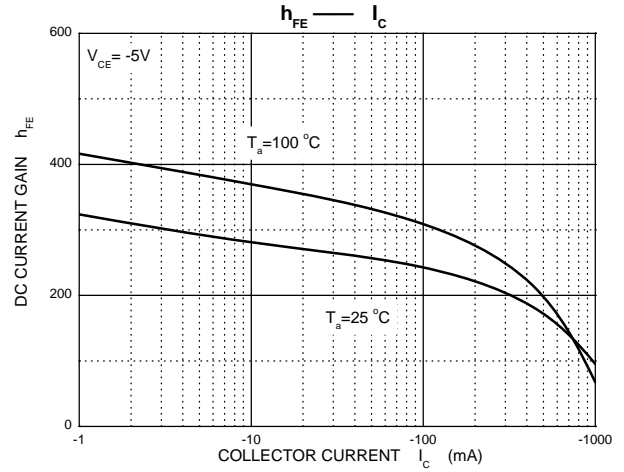
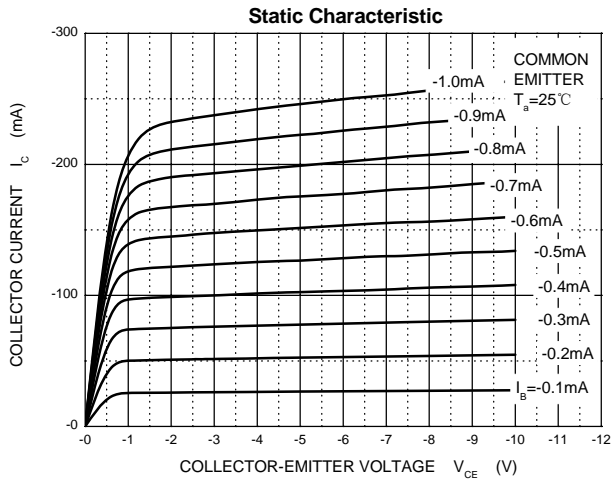

TO-92L Package Outline Dimensions

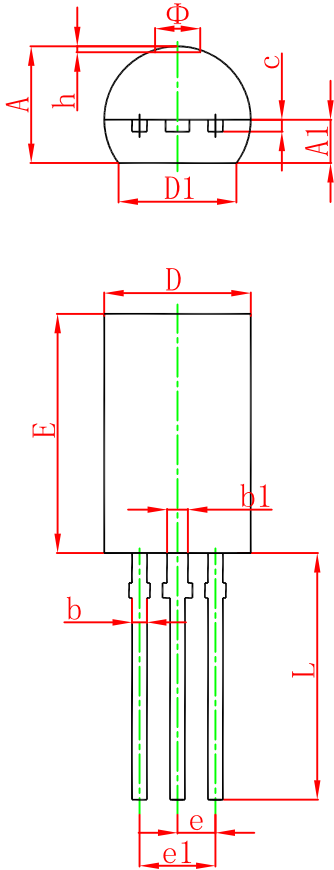

Symbol	Dimensions In Millimeters		Dimensions In Inches	
	Min.	Max.	Min.	Max.
A	3.750	4.050	0.148	0.159
A1	1.280	1.580	0.050	0.062
b	0.380	0.550	0.015	0.022
b1	0.620	0.780	0.024	0.031
c	0.350	0.450	0.014	0.018
D	4.750	5.050	0.187	0.199
D1	4.000		0.157	
E	7.850	8.150	0.309	0.321
e	1.270 TYP.		0.050 TYP.	
e1	2.440	2.640	0.096	0.104
L	13.800	14.200	0.543	0.559
Φ		1.600		0.063
h	0.000	0.300	0.000	0.012

TO-92L Suggested Pad Layout

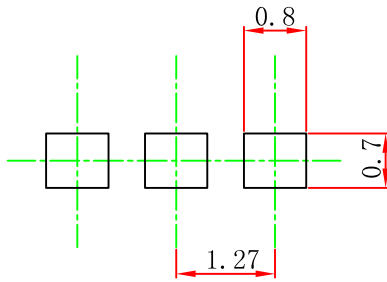

Note:

1. Controlling dimension: in millimeters.
2. General tolerance: ± 0.05 mm.
3. The pad layout is for reference purposes only.

NOTICE

JCET reserve the right to make modifications, enhancements, improvements, corrections or other changes without further notice to any product herein. JCET does not assume any liability arising out of the application or use of any product described herein.

TO-92L PACKAGE TAPING DIMENSION

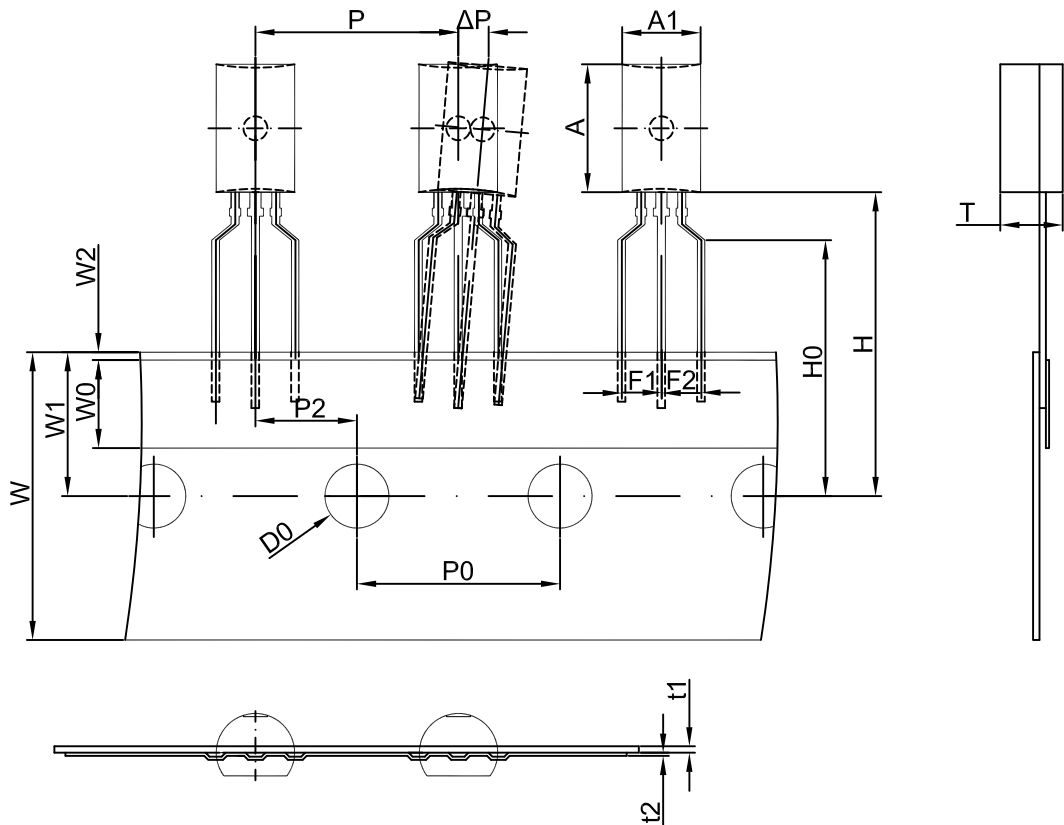

Dimensions are in millimeter

A1	A	T	P	P0	P2	F1	F2	W
4.9	8.0	3.9	12.7	12.7	6.35	2.5	2.5	18.0
W0	W1	W2	H	H0	D0	t1	t2	ΔP
6.0	9.0	1.0	19.0	16.0	4.0	0.4	0.2	0

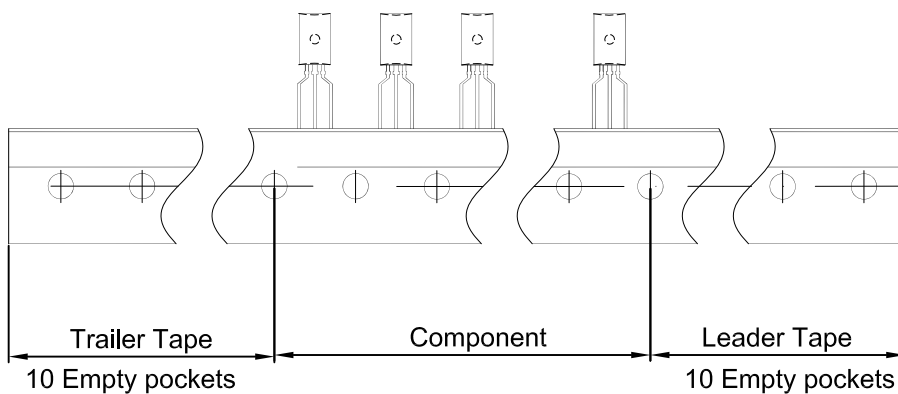

Package	Box	Box Size(mm)	Carton	Carton Size(mm)
TO-92L	2000 pcs	333×203×42	20,000 pcs	493×400×264